



---

## Cladistic Analysis of the South American Species of *Tricorythodes* (Ephemeroptera: Leptohiphidae) with the Description of New Species and Stages

---

C. Molineri

National University of Tucumán, Argentina

---

### Abstract

Fifteen species of the genus *Tricorythodes* are treated: *T. arequita* Traver, *T. australis* (Banks), *T. barbatus* Allen, *T. bullus* Allen, *T. cristatus* Allen, *T. curiosus* (Lugo-Ortiz & McCafferty) comb. nov., *T. hiemalis* Molineri, *T. mirca* sp. nov., *T. nicholsae* (Wang et al.) comb. nov., *T. ocellus* Allen & Roback, *T. popayanicus* Domínguez, *T. quizeri* sp. nov., *T. santarita* Traver, *T. yura* sp. nov. and *T. zunigae* sp. nov. A matrix of 17 taxa and 28 characters was analyzed cladistically using the program PIWE (Parsimony with Implied Weights, Goloboff, 1993a). *Haplohyphes furtiva* Domínguez and *Leptohiphes eximius* Eaton were used to root the tree. Only one tree of maximum fit was obtained supporting the new combinations *T. curiosus* and *T. nicholsae*, the monophyly of the genus and the invalidity, at least in part, of Allen and Murvosh's (1987) subgenera. The following species are described for the first time from all the stages: *T. mirca* sp. nov., *T. quizeri* sp. nov., *T. yura* sp. nov. and *T. zunigae* sp. nov. The following stages are described for the first time: nymph and imagines of both sexes of *T. arequita*, nymph and male imago of *T. santarita*, male and female imagines of *T. bullus*. The following stages are redescribed: nymphs of *T. barbatus* and female imago of *T. santarita*. Distributional records, diagnoses and keys to distinguish all the South American species of *Tricorythodes* are given.

**Keywords:** Neotropics, cladistics, new combinations, new species, *Tricorythodes*.

### Introduction

The genus *Tricorythodes* Ulmer (1920) is a well-defined group of mayflies supported by numerous characters. Nymphs of this genus are mainly small and stout crawlers that inhabit mountain streams, mainly in the small patches of sand between boulders. Their body, legs and opercular triangular gills are covered with long setae. The adults

are small, dipterous mayflies with very broad wings and with a basal swelling in the second joint of male's forceps.

Only two species of South American *Tricorythodes* are known from all the stages: *T. popayanicus* Domínguez and *T. hiemalis* Molineri, both distributed in north-western Argentina. Four other species are known only from nymphs: *T. barbatus* Allen, *T. bullus* Allen, *T. cristatus* Allen and *T. ocellus* Allen & Roback. Four species are known only from adults: *T. arequita* Traver (known from male subimagines), *T. australis* (Banks), *T. lichyi* Traver and *T. santarita* Traver (known from a single female).

Allen and Murvosh (1987) proposed three subgenera of *Tricorythodes*: *Tricorythodes* Ulmer, *Tricorythyphes* Allen and Murvosh and *Homolepto-hyphes* Allen and Murvosh. Each of these groups is defined mainly by characters on opercular gills and legs of the nymphs. Recently Wiersema and McCafferty (2000) elevated them to generic level, proposing two new genera: *Asioplax* and *Epiphra-des*, thus subdividing the genus *Tricorythodes* in five genera. These subgenera/genera are not followed here for reasons discussed later.

In the present paper three new species from Bolivia and one from Colombia are described from all the stages: *T. mirca* sp. nov., *T. quizeri* sp. nov., *T. yura* sp. nov. and *T. zunigae* sp. nov. Male and female imagines of *T. bullus* Allen (1967), imagines of both sexes and nymphs of *T. arequita* Traver (1959) and male imagines and nymphs of *T. santarita* Traver (1959) are described for the first time. Nymphs of *T. barbatus* Allen (1967) and female imagines of *T. santarita* are redescribed.

*T. arequita*, *T. australis*, *T. barbatus*, *T. bullus* and *T. santarita* are recorded for the first time from Argentina.

The types of *T. ocellus* Allen and *T. cristatus* Allen were studied and a brief discussion with illustrations to separate these species from the others of the genus is included. A discussion and drawings are presented for nymphs determined as *Lepto-hyphes curiosus* Lugo-Ortiz & McCafferty (1995) and this species along with *L. nicholsae* Wang et al. (1998) is here transferred to *Tricorythodes*.

Distribution records for *T. hiemalis* Molineri and *T. popayanicus* Domínguez and keys to distinguish adults and nymphs of all the South American species of the genus are given.

## Material and methods

The material is deposited in the following institutions: IFML = Instituto-Fundación Miguel Lillo, San Miguel de Tucumán, Tucumán, Argentina; UMSA = Universidad Mayor de San Andrés, Instituto de Ecología, Unidad de Limnología, La Paz, Bolivia; MCFU = Museo de Ciencias de la Facultad de Uruguay, Montevideo, Uruguay; MEUV = Museo de Entomología de la Universidad del Valle (Cali, Colombia); Cal = California Academy of Science (San Francisco, USA); FAMU = Florida A&M University, Tallahassee (Florida, USA). Collectors marked "D., M. & N." mean E. Domínguez, C. Molineri and C. Nieto. The length of mesonotum + wingpads was measured only when mature nymphs were available, from the anterior-most point of mesonotum to the distal apex of wingcases.

## Descriptions

### *Tricorythodes arequita* Traver (Figs. 1–18)

*T. arequita* Traver, 1959: 128.

*Male imago.* Length: body, 4.5–5.0 mm; forewings, 4.7–5.2 mm. General coloration greyish-brown. Head yellowish-brown, shaded with brownish-black on a longitudinal band between median ocellus and hind margin and on a transverse line between lateral ocelli; antennae whitish-yellow.

Thorax. Pronotum heavily shaded with black except small and scattered whitish dots. Mesonotum brown shaded with black, mesoscutellum blackish with short membranous filaments, not reaching the tip of this sclerite, lateral zones of mesoscutellum yellowish. Metanotum greyish-brown. Pleural and sternal sclerites orangish-brown, shaded with black on membranes. Legs (Fig. 4): coxa and trochanters yellowish-brown shaded with grey. Femora yellowish with distal 2/3 shaded with brownish-grey, heavier on a thin subapical band. Fore tibiae whitish except base yellowish, shaded completely with grey, with a black subapical band; fore tarsi whitish shaded slightly with grey, except base of tarsal claws blackish. Tibiae and tarsi of median and hind legs whitish, with notorious subapical black bands on tibiae and base of claws. Wings (Fig. 1): membrane hyaline shaded with grey at base and C and Sc sectors; longitudinal veins shaded with black; cross veins lighter, darkening toward costal margin.

Abdomen light brownish yellow, except intersegmental membranes, whitish. Abdominal terga shaded with black almost completely, except small and scattered whitish dots (similar to Fig. 3), sterna shaded more slightly, except ganglionar zones, greyish. Genitalia (Fig. 5) whitish-translucent except distal margin of styliger plate and lateral margins of penes, yellowish, shaded with blackish on lateral zones of styliger plate. Caudal filaments whitish-translucent, shaded heavily with grey on basal segment of cerci, remaining segments shaded much more slightly.

*Female imago.* Length: body, 5.0–6.0 mm; forewings, 6.0–7.0 mm. As in the male except forelegs similar to the remaining pairs, wings longer (Fig. 2). Abdomen yellowish when full of eggs, shaded with blackish as in Fig. 3. Terminal filament 40% longer than wing, cerci short (1/3 of wing length).

*Nymph.* Length: 4.8–5.5 mm, mesonotum + wingpads 1.4–2.1 mm; cerci 3.5–4.0 mm; terminal filament, 5.0 mm. General coloration yellowish with blackish marks, body covered with long setae.

Head whitish-yellow shaded with blackish except around antennae and a pair of circular spots behind lateral ocelli; antennae and mouth parts yellowish, shaded with grey on submentum; maxillary palp 3-segmented, and short (Figs. 7–9). Thorax. Anterolateral corners of pronotum acute and forwardly projected.

Thorax extensively shaded with irregular blackish marks on dorsum, sterna paler. Legs (Figs. 11, 12) with heavy subapical blackish bands on femora, tibiae and tarsi.

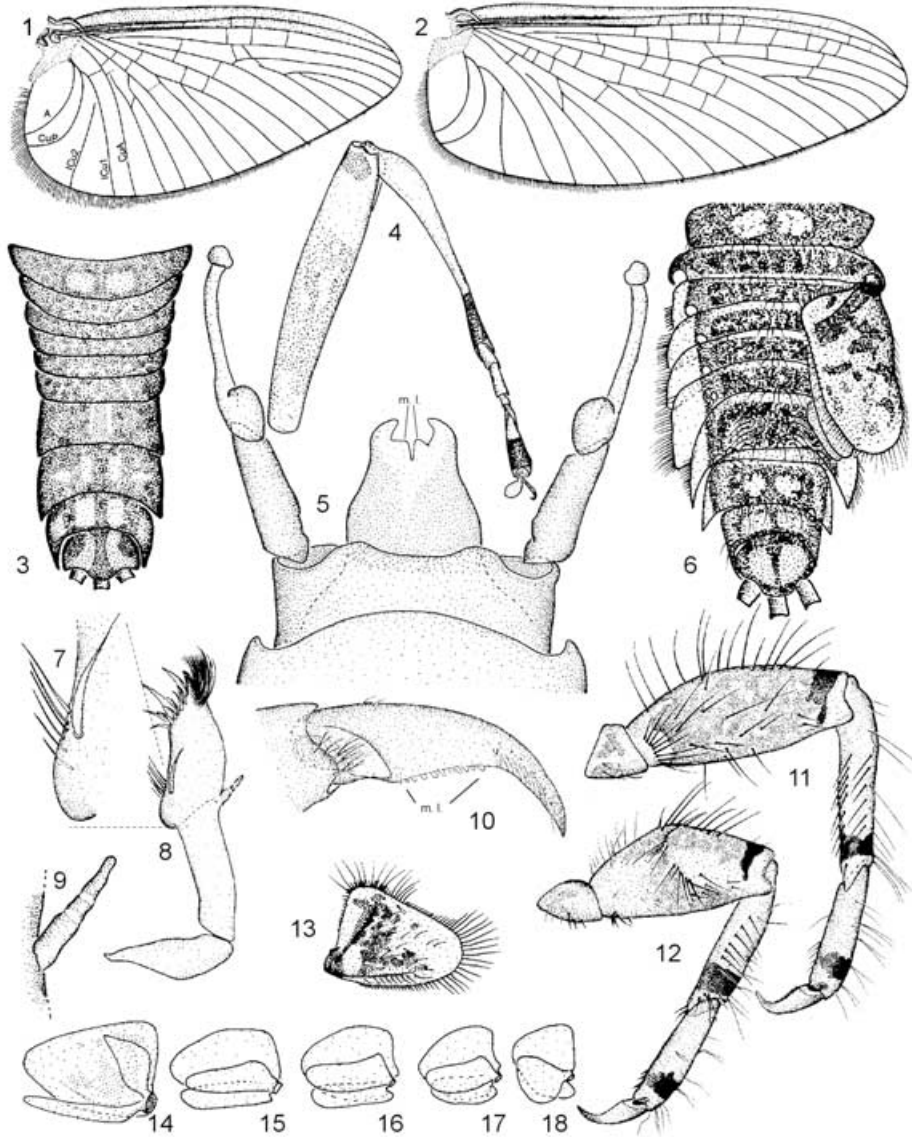

Figures 1–18. *T. arequita*. Adult: (1) forewing ♂; (2) forewing ♀; (3) abdomen, ♀, d.v.; (4) mesothoracic leg ♂; (5) genitalia ♂, v.v. Nymph: (6) abdomen, d.v.; (7) detail of maxillae, d.v.; (8) maxillae, d.v.; (9) maxillary palp; (10) fore tarsal claw; (11) hind leg; (12) foreleg; (13) gill II, d.v.; (14) gill II, v.v.; (15–18) gills III–VI, v.v. Captions: m.l., median lobes of penes; m.d., marginal denticles of tarsal claws.

Femora with an additional greyish band on median zone. Tarsal claws with 11–12 basal and marginal denticles and a pair of submarginal denticles near apex, claws with a distal setae (Fig. 10). Width/length ratio of femora: forelegs 0.4–0.5, median and hind legs 0.3–0.4.

Abdomen almost completely shaded with black except sublateral zones of terga I and VIII–X (Fig. 6). Opercular gills triangular, with blackish marks as in Fig. 13, with a pair of ventral membranous lamellae (Fig. 14); remaining gills whitish-translucent shaded with grey (Figs. 15–18). Abdominal sterna paler, with greyish ganglia. Margins of segments III–VIII expanded laterally, with posterolateral spines on segments VII–IX, very short on IX (Fig. 6). Hind margins of abdominal terga with rows of long setae, more notorious on terga I–II and VI–VIII. Caudal filaments yellowish-translucent shaded with grey.

*Life cycle associations.* Male and female adults were associated by colour pattern and wing venation, adults and nymph by a reared female subimago.

*Material.* Holotype male subimago (dissected, without references to slides) from: URUGUAY, Lavalleja, Arequita (Urug. 4), 2-I-1951, C. S. Carbonell et al. legs. Paratypes: 2 male subimagines same data as holotype. Holotype and 1 paratype in MCFU, 1 paratype in FAMU. Other material: 12 female and 12 male imagines, 1 female subimago (reared) and 2 nymphs from ARGENTINA, Misiones, Parque Provincial Urugua-í, Uruzú Stream, 7–11-XII-1999, Molineri col.; 7 male imagines same locality except date and collector: 23–24-XI-1998, D. M. & N.; 1 nymph from Misiones, Aristóbulo del Valle, Ruta Prov. 7, Río Cuñá-Pirú, 19–20-XI-1998 and 5 nymphs from Misiones, junction of rivers Alegría and Piray-Guazú, 3–4-XII-1986, Domínguez col., all this material deposited in IFML; 1 male imago from BRAZIL, Rio Grande do Sul, Rio Ivay, 28°48'S, 53°42'W, 350 m, XI-1964, F. Plaumann, deposited in FAMU (GFE 00973).

*Discussion.* *T. arequita* was described by Traver (1959) from male subimagines collected in Uruguay. Traver distinguished this species from the other of the genus because the pair of fore tarsal claws are dissimilar, one blunt paddle like and the other apically hooked. This is so in the subimaginal stage of all the species of the family and only after the imaginal ecdysis both claws of fore tarsi become blunt. For this reason this character is no longer valid to distinguish *T. arequita*. *T. arequita* can be distinguished from the other species of the genus by the following combination of characters. In the imago: (1) abdomen shaded with black almost completely, with small whitish dots (Fig. 3); (2) tibiae and tarsi whitish with notorious subapical blackish bands (Fig. 4); (3) penes broad and flattened (Fig. 5); (4) ratio segment 1/segment 2 of forceps: 0.8; (5) vein CuP present. In the nymph: (1) abdominal colour pattern as in Fig. 6; (2) opercular gill shaded with black as in Fig. 13; (3) maxillary palp 3-segmented and short (Figs. 8, 9); (4) position of transversal row of setae on fore femora: submedian; (5) legs with subapical blackish marks on femora, tibiae and tarsi (Figs. 11, 12); (6) tarsal claws with 11–13 basal marginal denticles and a pair of submarginal denticles near apex (Fig. 10).

*T. arequita* is redescribed from newly collected material from Misiones (Argentina). The holotype and paratypes are too faded to see the colour pattern, but the characteristic blackish marks are still visible on the apex of tibiae and tarsi. Other characters of male genitalia, general coloration, body and wing length and wing venation are the same in both materials.

***Tricorythodes australis* (Banks) (Figs. 19–23)**

*Tricorythus australis* Banks, 1913: 85.

*Leptohiphodes australis* — Ulmer, 1920: 50.

*Tricorythodes australis* — Traver, 1958: 501–503.

*Material.* 5 male imagines from ARGENTINA, Misiones, Parque Nacional Iguazú, Puerto Canoas, Río Iguazú, 26-XI-1998, D., M. & N. cols. (IFML); 12 male imagines from BRAZIL, Para, Rio Xingú, camp (3°39'S, 52°22'W), ca 60 km S Altamira, 1–21-X-1986, P. Spangler & O. Flint (NMNH); 2 male and 1 female imagines from BRAZIL: Paraná State, Rio Paraná, Guairá, 650', 10-III-1969, W.L. Peters & J.G. Peters (FAMU); 11 male and 1 female imagines from BRAZIL: Mato Grosso St., Rio Jaurua, 10 km W of Cáceres, 8-III-1986 (FAMU).

*Discussion.* This species originally described by Banks (1913) was adequately redescribed by Traver (1958) from imagines of both sexes. As Traver noted the basal swelling of the 2nd joint of the forceps, so typical of *Tricorythodes*, is absent. This situation along with the absence of the longitudinal vein CuP on male forewings and the form and structure of penes led Traver to suggest that *T. australis* was an aberrant member of *Tricorythodes*. The position of *T. australis* in the cladogram here proposed, if not fully determined, is basal to all the species of *Tricorythodes* (except *T. barbatus*). This stresses the fact that *T. australis* should not be included in *Tricorythodes* but it seems inconvenient to erect a new genus for this species until nymphs are known. Male imagines of *T. australis* can be distinguished from the other species of the genus by the following combination of characters: (1) abdomen shaded uniformly with grey; (2) tibiae and tarsi without blackish marks; (3) penes with a ventral projection covered with setae (Fig. 22); (4) forceps: first segment very short and second segment without basal swelling (Figs. 19, 20); (5) vein CuP absent in males (Fig. 23), sometimes present but rudimentary in females.

***Tricorythodes barbatus* Allen (Figs. 24–36)**

*Tricorythodes barbatus* Allen, 1967: 373.

*Tricorythodes (Tricorythodes) barbatus* — Allen and Murvosh, 1987: 36.

*Tricorythyphes barbatus* — Wiersema and McCafferty, 2000: 353

*Imagines.* Unknown.

*Nymph* (nearly mature). Length: body, 7 mm; cerci, 2.5 mm; terminal filament, 3.5 mm; mesonotum + wingpads, 2.1 mm. General coloration whitish-yellow, completely shaded with greyish-black.

Head yellowish with blackish marks as in Fig. 26. Mouthparts: maxillary palp small, apparently 3-segmented with apical setae (Figs. 29, 30); submentum blackish, remaining mouthparts whitish.

Thorax. Pronotum yellowish completely shaded with black except on a pair of submedian oval marks on hind margin. Mesonotum blackish with small irregular whitish marks; developing wings whitish except costal margin blackish. Metanotum completely shaded with black except pair of small submedian marks on hind margin. Pleurae whitish shaded with greyish-black on sclerites. Sterna greyish-black. Legs: coxae I and II blackish, coxae III greyish; femora of all legs greyish with depigmented zones as in Figs. 27, 28; tibiae I greyish, tibiae II and III whitish slightly shaded with

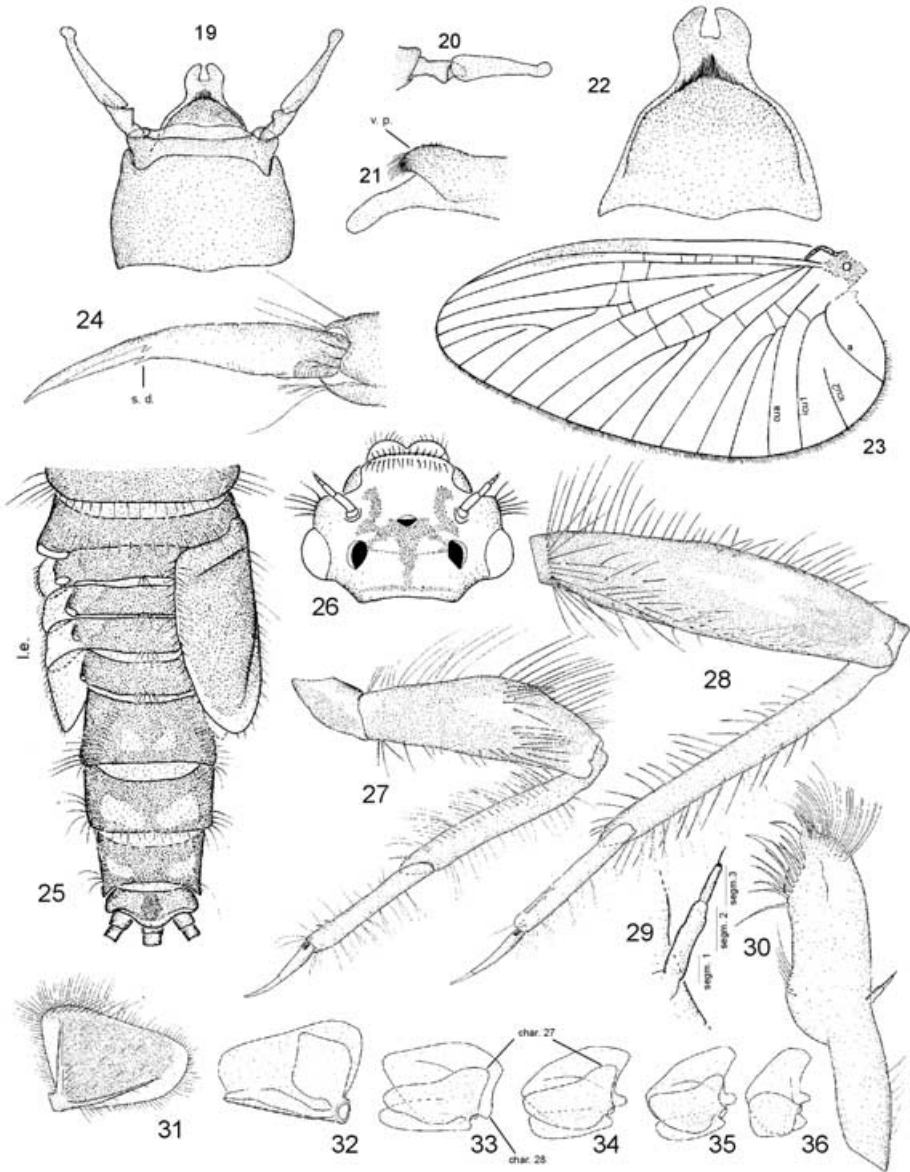

Figures 19–36. Figs. 19–23 *T. australis*, male imago: (19) genitalia, v.v.; (20) forceps, l.v.; (21) penes, l.v.; (22) penes, v.v.; (23) forewing. Figs. 24–36 *T. barbatus*, nymph: (24) fore tarsal claw; (25) abdomen, d.v.; (26) head, d.v.; (27) foreleg; (28) hind leg; (29) maxillary palp; (30) maxillae, v.v.; (31) gill II, d.v.; (32) gill II, v.v.; (33–36) gill III–VI, v.v. Captions: v.p., ventral projection of penes; s.d., submarginal denticles of tarsal claws; i.e., lateral extensions of abdominal segments.

light grey on hind tibiae, tarsi of all legs whitish. Tarsal claws long and slender, without marginal denticles, with a single pair of submarginal denticles near apex (Fig. 24).

Abdomen. Terga greyish-black except membranes whitish; terga VII–IX with a pair of triangular submedian lighter marks (Fig. 25). Abdominal sterna greyish, sternum IX with a pair of submedian irregular paler marks. Gills: opercular gills completely shaded with black (Fig. 31), ventral lamellae of gill II and remaining gills whitish-grey (Figs. 32–36). Caudal filaments whitish slightly shaded with grey.

*Material.* 2 nymphs, paratypes (in alcohol, parts of one of them dissected, on slides) from BRAZIL: Rio Jacutinga, 27°06'S, 51°36'W, 500 m, IV-1962, F. Plaumann, deposited in CAL. Voucher specimens: 3 nymphs from ARGENTINA, Misiones, San Vicente, 29-XI-1986, E. Domínguez col.; 2 nymphs from ARGENTINA, Misiones, Puerto Mado, 16-II-1985, E. Domínguez col. (IFML).

*Discussion.* In spite of the relatively extensive collections in Misiones only five immature nymphs of this species without associable adults were found. This suggests that *T. barbatus* is scarce at least in the summer season. The nymphs of this species can be distinguished from the other species of the genus by the following combination of characters: (1) abdomen with blackish marks as in Fig. 25; (2) opercular gill triangular and blackish (Fig. 31); (3) maxillary palpi 3-segmented with apical seta (Fig. 29); (4) position of transversal row of setae on fore femora: subdistal (Fig. 27); (5) tibiae and tarsi without blackish marks; (6) tarsal claws with a pair of submarginal denticles (Fig. 24); (7) very large size.

This species is similar to *Haplohyphes* nymphs in body form and leg setation but shows all the apomorphic characters of *Tricorythodes*. This situation is clearly shown in Fig. 173 below where *T. barbatus* appears as the first species splitting from *Tricorythodes*.

### *Tricorythodes bullus* Allen (Figs. 37–53)

*Tricorythodes bullus* Allen, 1967: 374.

*Tricorythodes (Tricorythodes) bullus* — Allen and Murvosh, 1987: 36.

*Epiphraides bullus* — Wiersema and McCafferty, 2000: 350.

*Male imago.* Length: body, 3.0–4.1 mm; forewings, 3.2–4.0 mm.

Head whitish-yellow shaded with black on hind margin, posterolateral corners and on a pair of submedian marks on occiput; shaded slightly on a pair of submedian marks among ocelli.

Thorax. Pronotum shaded completely with black except on median zone and three circular marks on lateral zone, paler. Mesonotum yellowish with blackish carinae and margins, shaded with greyish on a longitudinal blackish band interrupted on antero-scutum, without shading; the anterior margin of this band is V-shaped, and before the mesoscutellum this band turns darker; mesoscutellum blackish-brown with short membranous filaments not reaching the apex of the sclerite. Metanotum completely shaded with blackish. Pleurae and sterna of thorax yellowish shaded with grey at base of wings. Legs (Fig. 44) yellowish-white shaded with grey on a subapical mark of

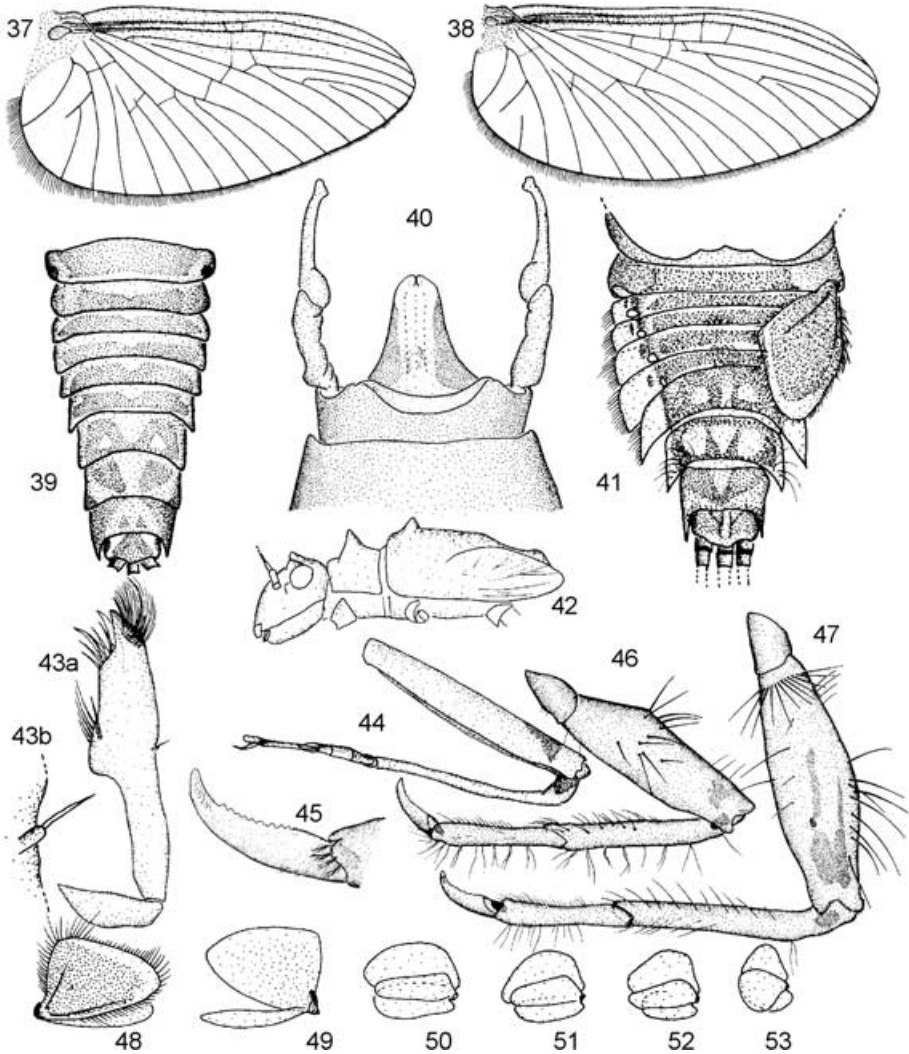

Figures 37–53. *T. bullus*: (37) forewing ♂; (38) forewing ♀; (39) abdomen, ♀, d.v.; (40) genitalia ♂, v.v.; (41) nymphal abdomen, d.v.; (42) nymphal head and thorax, l.v.; (43a) maxillae, d.v.; (43b) maxillary palp; (44) mesothoracic leg ♂; (45) foretarsal claw; (46) foreleg of nymph; (47) hind leg of nymph; (48) gill II, d.v.; (49) gill II, v.v.; (50–53) gills III–VI, v.v.

each femur and on a blackish mark on the base of each tibia; on hind femora the blackish mark may extend to the median zone. Wings (Fig. 37): membrane hyaline shaded with grey from the costal margin to radial sector; longitudinal veins shaded with grey, cross veins hyaline except those on radial sector, blackish.

Abdomen whitish-yellow, translucent on segments I–VII. Terga I–VI with a transverse blackish band, terga VII–IX shaded with blackish except on mediolongitudinal band and on a pair of submedian triangular marks; hind margin of terga IX–X shaded with black (similar to Fig. 39). Abdominal sterna whitish-translucent with a double row of small blackish marks near spiracles. Genitalia whitish-translucent, penes shaded with grey at base and with brown at lateral margins (Fig. 40). Caudal filaments whitish-translucent slightly shaded with grey, darker at joinings.

*Female imago.* Length: body, 3.0–3.5 mm; forewings, 4.0–4.3 mm. As in male imago except shaded with black more extensively on head and pronotum. Wings as male imago except distal half of C and Sc sectors whitish-translucent (Fig. 38). Abdomen shaded with grey as in Fig. 39. Terminal filament 1/2 of wing length, cerci less than 1/3 of wing length.

*Nymph.* Length of female: body, 3.4–4.5 mm; cerci, 1.9–2.0 mm; terminal filament, 2.5 mm; mesonotum + wingpads, 1.4–1.5 mm. Length of male: body, 3.0–3.1 mm; cerci, 1.6 mm; terminal filament, 2.0 mm; mesonotum + wingpads, 1.2 mm. Just a few characters are necessary to complete the original description by Allen. The occipital tubercle on the head is bifurcated at the apex. The colour pattern is similar to the adults, mainly on legs (Figs. 46, 47) and abdomen (Fig. 41). Maxillae (Fig. 42) with 1-segmented palp and apical setae (Fig. 43). Legs: with a row of branched setae in the apex of tarsi (Fig. 45), tarsal claws with 8–11 marginal denticles (Fig. 45). In some nymphs the base of the wingpads is shaded with blackish. Gills: gills II formed by two lamellae (Figs. 48, 49); gills III–VI as in Figs. 50–53.

*Observations.* A great amount of variation was found in the adult size, in the same swarms were collected small, medium size and large individuals. The femora of some individuals are completely shaded with grey.

*Life cycle associations:* by reared nymphs of both sexes.

*Material.* One nymph paratype (in alcohol) from BRAZIL: Nova Teutonia, III-1962, F. Plaumann; 1 nymph paratype (in alcohol, mouthparts on slide) from BRAZIL: Nova Teutonia, River Ariranha, 27°11'S, 52°23'W, XII-1961, F. Plaumann, both deposited in FAMU (No. E2031.T). Voucher specimens (IFML): 50 males, 50 females, 2 reared females, 3 male subimagines inside nymphal cuticle and 10 nymphs from ARGENTINA: Misiones, Aristóbulo del Valle, Ruta Provincial 7, Río Cuñá-Pirú, 19–20-XI-1998, D., M. & N. cols. Numerous nymphs and adults from the following localities in Misiones (ARGENTINA): Bompland, 15-II-1985, E. Domínguez and 18-VIII-1998, D., M. & N.; Parque Provincial Urugua-í, 23–24-XI-1998, D., M. & N. and 7–11-XII-1999, Molineri; Paraíso (A° Fortaleza), 2-XII-1986, Domínguez; Puerto Mado (A° Yacutinga), 16-II-1985, Domínguez and 19–20-XI-1998, D., M. & N.; San Vicente, 30-XI-1986, Domínguez and 20-XI-1998, D., M. & N.; Iguazú (Puerto Canoas), 26-XI-1998, D., M. & N.; El Soberbio, 21-XI-1998, D., M. & N.; Cerro Azul (A° Mártires), 17-XI-1998, D., M. & N.; junction of rivers Alegría and Pirai-Guazú, 22–23-XI-1998, D., M. & N.

*Discussion.* *T. bullus* can be distinguished from the other species of the genus by the following combination of characters: (1) abdominal colour pattern as in Fig. 39; (2) legs with greyish-black marks on apex of femora and base of tibiae (Fig. 44); (3) penes more or less pyramidal (Fig. 40); (4) ratio segment 1/segment 2 of forceps: 1.0–1.1; (5) vein CuP incomplete (Figs. 37, 38). In the nymph: (1) abdominal

colour pattern as in Fig. 41; (2) opercular gills blackish as in Fig. 48; (3) maxillary palp 1-segmented with apical seta (Figs. 42, 43); (4) transversal row of spines on fore femora: subbasal (Fig. 46); (5) tibiae and tarsi without blackish marks; (6) tarsal claws with 8–11 marginal denticles (Fig. 45); (7) tubercles present on head, pronotum and mesonotum.

### *Tricorythodes cristatus* Allen (Figs. 54–59)

*Tricorythodes cristatus* Allen, 1967: 373.

*Tricorythodes (Tricorythodes) cristatus* — Allen and Murvosh, 1987: 36.

*Epiphraodes cristatus* — Wiersema and McCafferty, 2000: 350.

*Material.* Three slides labeled as “*T. grallator*” were studied at FAMU. No published species in the genus have such a name. Locality and parts correspond exactly with *T. cristatus*, thus here it is assumed that the labels on the slides are in error. One of the slides has six legs of a nymph, the second shows the mouthparts and the third has an entire head, all of them from: BRAZIL, brook at Serra do Mar, V-1964, F. Plaumann, deposited in FAMU (E2065.T).

*Discussion.* *T. cristatus* is presently known only from nymphs from Serra do Mar (SE of Brazil). I could not study the bodies of the types because only slides were available but from original descriptions and drawings we can see the differences with its sister species, *T. bullus*. They can be separated because the tubercles on the thorax are much shorter in *T. cristatus* (Fig. 57). Both species show also some characters in common with *T. santarita* species group (Fig. 173). Nymphs of *T. cristatus* can be distinguished from the other species of the genus by the following combination of characters: (1) abdominal colour pattern “black with pale markings” (Allen, 1967: 373); (2) opercular gill shaded completely with black; (3) maxillary palp 1-segmented with apical seta (Fig. 58); (4) position of transversal row on fore femora: subbasal (Fig. 55); (5) legs without subapical blackish marks on tibiae or tarsi; (6) tarsal claws with 16–18 marginal denticles and without submarginal denticles (Fig. 56).

### *Tricorythodes curiosus* (Lugo-Ortiz & McCafferty) comb. nov. (Figs. 60–70)

*Leptohiphes curiosus* Lugo Ortiz and McCafferty, 1995: 170.

*Asioplax curiosa* — Wiersema and McCafferty, 2000: 348.

*Material.* Six nymphs from Panama: Boca del Toro, Río Changuinola at Zegla, 24-IV-1985, R.W. Flowers col. (FAMU).

*Discussion.* Some nymphs of this species were collected by R.W. Flowers in Panama who kindly made them available for study. The developing male genitalia of one of these nymphs (pharate subimago), was dissected and is typical for the genus *Tricorythodes* (Fig. 60). As is shown in the hypothesis of relationships (Fig. 173) this species is without doubt a *Tricorythodes*. Recently Wiersema and McCafferty proposed the genus *Asioplax* for this and other species. This classification is not followed here because, as shown in the cladogram (Fig. 173), this group of species is just an apomorphic clade within *Tricorythodes*. A few drawings of legs (Figs. 61, 62), maxillae (Fig. 64) and gills (Figs. 65–70) of these nymphs are added to

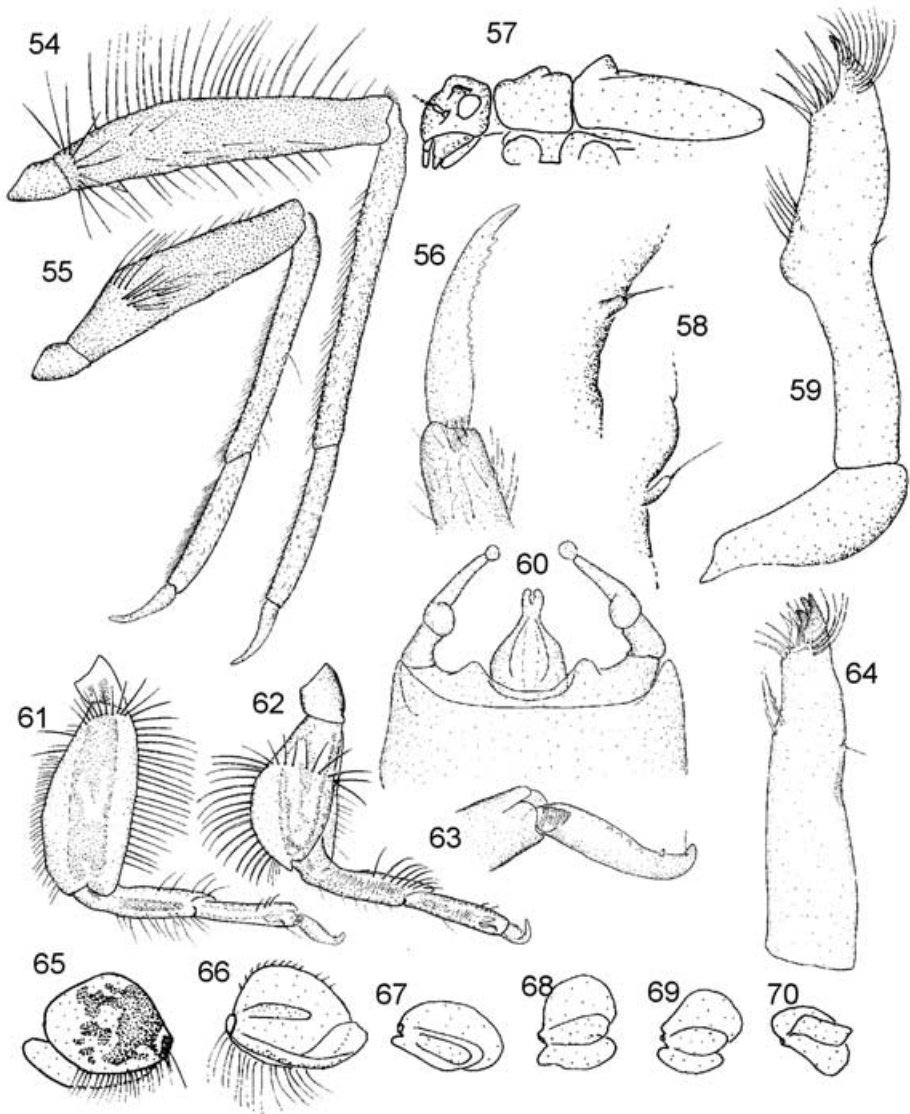

Figures 54–69. Figs. 54–59 *T. cristatus*, nymph: (54) hind leg; (55) foreleg; (56) fore tarsal claw; (57) head and thorax, l.v.; (58) maxillary palpi; (59) maxillae. Figs. 60–70 *T. curiosus*, nymph: (60) male genitalia of pharate subimago; (61) hind leg; (62) foreleg; (63) tarsal claw; (64) maxillae; (65) gill II, d.v.; (66) gill II, v.v.; (67–70) gills III–VI, v.v.

facilitate its identification. *T. curiosus* comb. nov. can be distinguished from the other species of the genus by the same combination of characters used for *T. santarita*. *T. curiosus* can be distinguished from the other species of the *T. santarita* species group by the absence of median tubercles on the abdominal terga; a situation shared with

*T. zunigae* sp. nov. from which it can be separated by the oval form of the opercular gill (Fig. 65).

***Tricorythodes hiemalis* Molineri**

*Tricorythodes hiemalis* Molineri, 2001: 61.

*Material.* Holotype male imago, allotype female imago and 33 paratype nymphs from: ARGENTINA, Salta, P. N. El Rey, Las Salas Stream, 24°43'35"S, 64°39'44"W, 6-VI-1998, D., M. & N. cols. (IFML). New record: 1 nymph from: ARGENTINA, Jujuy, R. Zora, 23°45'04"S, 64°41'27"W, 410 m, 2-VI-2000, Molineri col.

*Discussion.* *T. hiemalis* can be distinguished from the other species of the genus by the following combination of characters. In the imago: (1) abdominal segments I–II and VII–X shaded with grey heavier than segments III–VI; (2) femora without markings or with a greyish subapical band, tibiae and tarsi without blackish marks; (3) penes wide at base becoming abruptly narrower in distal half; (4) ratio segment 1/segment 2 of forceps: 1.2; (5) vein CuP present. In the nymphs: (1) abdomen colour pattern as in imagines; (2) opercular gill triangular and blackish; (3) maxillary palp 2-segmented with apical setae; (4) transversal row of setae on fore femora: submedian; (5) tibiae and tarsi without blackish marks; (6) tarsal claws with 3–4 marginal denticles and a single pair of submarginal denticles. *T. hiemalis* is very closely related to *T. quizeri* sp. nov. (see below), sharing general aspect, coloration patterns, general form of male genitalia and nymphal tarsal claw denticulation.

***Tricorythodes mirca* sp. nov. (Figs. 71–85)**

*Male imago.* Length: body, 3.25–3.75 mm; fore wings, 3.25–3.75 mm. General coloration: thorax brown, legs and abdomen whitish with blackish and brownish marks.

Head yellowish-brown shaded with black on hind margin, around base of antennae and in remnants of mouthparts.

Thorax. Pronotum yellowish-brown shaded completely with black, propleurae and prosterna whitish-translucent shaded slightly with grey. Mesonotum brown shaded with grey; mesopleurae and mesosternum yellowish-brown except membranes whitish-yellow, shaded with grey on carinae. Metanotum yellowish-brown shaded with grey, rest of metathorax whitish-yellow. Legs: coxae and trochanters yellowish shaded with grey; fore femora whitish-yellow, fore tibiae yellowish-translucent, fore tarsi and remaining segments of meso- and hind legs whitish; legs shaded with yellowish-brown and blackish-grey on a median and a subapical band on all femora and with a small blackish mark on the apex of all tibiae (Fig. 73). Wings (similar to Fig. 1). Membrane of forewings hyaline, longitudinal and cross veins whitish-translucent shaded with grey from costal margin to radial sector.

Abdomen. Terga yellowish, shaded with black except intersegmental membranes and lateral zones of terga III–VII whitish as in Fig. 72; pleural membranes with blackish marks, sterna whitish shaded with grey on lateral zones and near hind margins (Fig. 74). Genitalia (Fig. 71): styliger plate yellowish-white shaded with grey, forceps whitish and penes yellowish-translucent. Caudal filaments whitish-translucent.

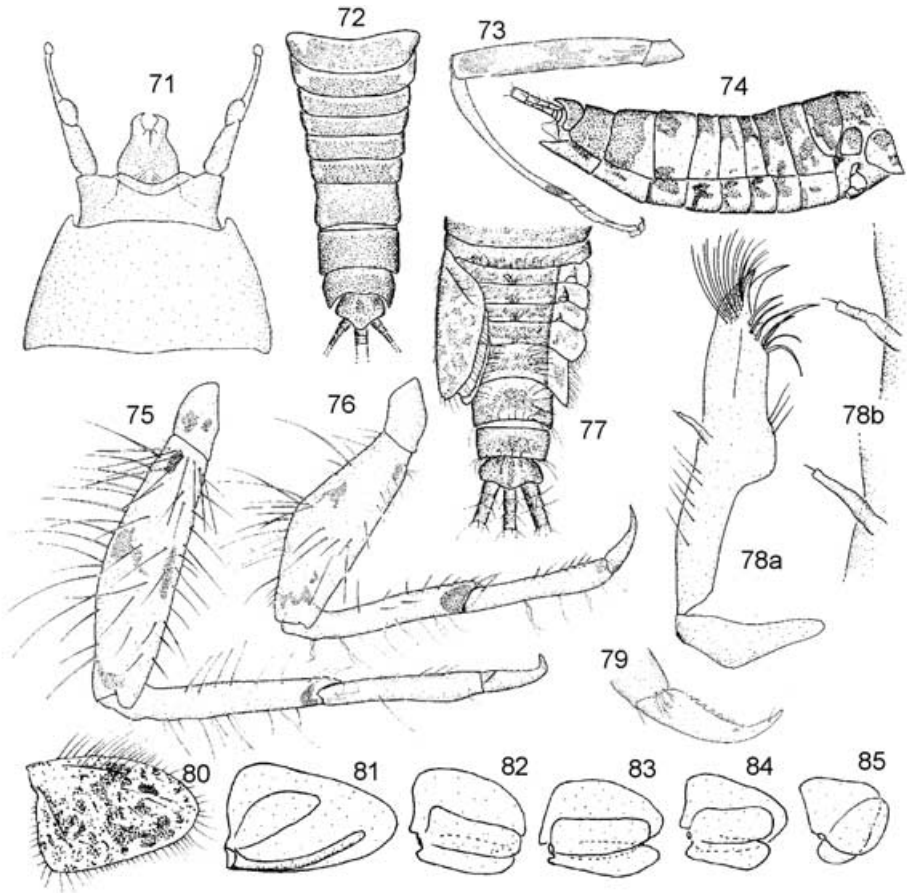

Figures 70–85. *T. mirca* sp. nov. Imago: (71) male genitalia; (72) female abdomen, d.v.; (73) male mesothoracic leg; (74) female abdomen, l.v. Nymph: (75) hind leg; (76) foreleg; (77) abdomen, d.v.; (78a) maxillae; (78b) maxillary palpi; (79) fore tarsal claw; (80) gill II, d.v.; (81) gill II, v.v.; (82–85) gills III–VI, v.v.

*Observations.* In some males the shading on thorax and abdomen is orangish-brown instead of blackish or greyish.

*Female imago.* Length: body, 3.25–3.75 mm; forewings, 3.75–4.0 mm. General coloration lighter than male. Head, thorax and abdomen as in male except usual sexual dimorphism. Eggs filling the abdomen yellowish. Abdominal shading lighter than in male, the stronger marks are on pleurae II and IV–VII (Figs. 72, 74). Caudal filaments whitish-translucent, cerci much shorter and thinner than terminal filament.

*Nymph.* Length: body, 3.75–4.10 mm; mesonotum, 1.4–1.5 mm; hind femora, 0.8–1.0 mm; terminal filament, 2.5–3.3 mm; cerci, 2.5–3.0 mm. General coloration yellowish.

wish with blackish marks, some nymphs with a strong blackish mediolongitudinal line along the dorsum of body.

Head yellowish-white shaded with grey on occiput, around base of antennae and on submentum.

Thorax whitish-yellow shaded completely with grey except lateral margins of pronotum and irregular marks on mesonotum, developing wings whitish with greyish costal margin. Thoracic sterna yellowish-white. Legs yellowish-white with transversal grey bands on median and subapical zones of all femora, and with blackish marks on the apex of all tibiae (Figs. 75, 76).

Abdomen yellowish-white shaded irregularly with grey mainly toward posterior margins of terga, shaded lighter on the zones covered by gills. Opercular gills translucent yellowish-white completely covered with blackish irregular marks (Figs. 80, 81); remaining gills (Figs. 82–85) whitish-translucent shaded with light grey. Abdominal sterna whitish shaded with grey toward posterior and lateral zones, shaded more markedly on lateral margins, below gills (Fig. 77). Caudal filaments yellowish-translucent shaded with grey at base.

*Life cycle association.* Imagines of both sexes and nymphs of the same locality were associated by shared colour pattern.

*Material.* Holotype male imago from BOLIVIA: Río Bugres, 30km W San Matías, 16°22'13.7"S, 58°42'59.7"W, 100m, 21-VI-2000, E. Domínguez; paratypes: 14 male and 8 female imagines, 5 nymphs same data as holotype; 3 nymphs from BOLIVIA, Santa Cruz, Río de las Petas, 16°22'24"S, 59°10'38"W, 120m, 19-VI-2000, E. Domínguez. Holotype, 7 male and 4 female imagines and 4 nymphs deposited in UMSA; remaining material in IFML.

*Etymology.* “Mirca” is the Quechua voice for “spotted”, for the irregular distribution of pigments.

*Discussion.* *T. mirca* sp. nov. shows close affinities with *T. arequita* both sharing very similar male genitalia and colour pattern. A third species of this group was found in Bolivia but is not described here because the material is not adequate. *T. mirca* can be distinguished from the other species of the genus by the following combination of characters. In the imago: (1) abdomen shaded with black almost completely, but with small dots without pigment (Fig. 72); (2) tibiae whitish with notorious subapical blackish bands (Fig. 73); (3) penes broad and flattened (Fig. 71); (4) ratio segment 1/segment 2 of forceps: 0.8; (5) vein CuP present. In the nymph: (1) abdominal colour pattern as in Fig. 77; (2) opercular gill shaded with black as in Fig. 80; (3) maxillary palp 3-segmented with apical seta (Fig. 78b); (4) position of transversal row of setae on fore femora: submedian; (5) legs with subapical blackish marks on femora and tibiae (Figs. 75, 76); (6) tarsal claws with 8–9 basal marginal denticles and 2 or 3 submarginal denticles near apex (Fig. 79).

*T. mirca* is very closely related to *T. arequita* showing a very similar coloration and male genitalia. Both species can be distinguished, at both stages, because subapical blackish marks are present on tibiae and tarsi in *T. arequita* but only on tibiae in *T. mirca*.

***Tricorythodes nicholsae*** (Wang et al.) comb. nov.

*Leptohyphes nicholsae* Wang, Sites and McCafferty, 1998: 69.

*Asioplax nicholsae* — Wiersema and McCafferty, 2000: 348.

*Discussion.* Nymphs of this species were not studied but following the original description and illustrations I was able to include it in the phylogenetic analysis. The results on Fig. 173 show its close relationships with *T. santarita* and *T. curiosus* without any nexus with *L. eximius* included to test their permanence in *Leptohyphes*. Nymphs of this species are easily recognized by characters listed for *T. santarita*. Both species can be distinguished by the presence of tubercles on abdominal terga 3–9 in *T. nicholsae*, and on 6–9 in *T. santarita*. Due to all the characters mentioned in the phylogenetic discussion its placement in *Tricorythodes* is fully justified. Its inclusion in the genus *Asioplax* by Wiersema and McCafferty (2000) is not justified, as discussed later.

***Tricorythodes ocellus*** Allen & Roback (Figs. 86–91)

*Tricorythodes* sp. Roback, 1966: 150.

*Tricorythodes (Tricorythodes) ocellus* Allen & Roback, 1969: 378 (Figs. 17–19).

*Tricorythyphes ocellus* — Wiersema and McCafferty, 2000: 353.

*Material.* Holotype male mature nymph (in alcohol) from PERU, near Tingo María, Tulumayo River, 25-IX-1955, S.S. Roback. Paratype nymph (body in alcohol; head, mouthparts, legs and gill II on slides) same data as holotype (FAMU).

*Discussion.* This species was included in the cladistic analysis but the majority of characters could not be scored. *T. ocellus* is only known from two nymphs and can be separated from the other species of the genus by the following combination of characters: (1) abdomen with irregular black markings on tergum VII and a median black macula on terga VIII to X (from original description); (2) opercular gill triangular and shaded almost completely with black (Fig. 89); (3) maxillary palp 2-segmented (Figs. 90, 91); (4) transversal row of setae on fore femora submedian (Fig. 86); (5) tibiae and tarsi without blackish marks; (6) tarsal claws without marginal denticles, only with a pair of submarginal denticles near the apex (Fig. 87); (7) lateral ocelli very large, similar in size to compound eyes (Fig. 88).

***Tricorythodes popayanicus*** Domínguez (Figs. 92–103)

*Tricorythodes popayanicus* Domínguez, 1982: 331, Figs. 1–7. Domínguez, 1984: 103. Domínguez et al., 1994: 101, Figs. 6–9.

*Tricorythodes (Tricorythyphes) popayanicus* — Allen and Murvosh, 1987: 38.

*Tricorythyphes popyanicus* (sic) — Wiersema and McCafferty, 2000: 353.

*Material.* Holotype male imago, allotype female imago and paratypes adults and nymphs from: ARGENTINA, Salta, Anta, P. N. El Rey, Las Salas stream, 24°43'35"S, 64°39'44"W, 25-IV-1982 (IFML). This is a very common species in the stony and sandy bottoms of unpolluted rivers and streams from western Argentina. Other material studied from: Jujuy, Salta, Tucumán, Catamarca, San Luis and Córdoba provinces.

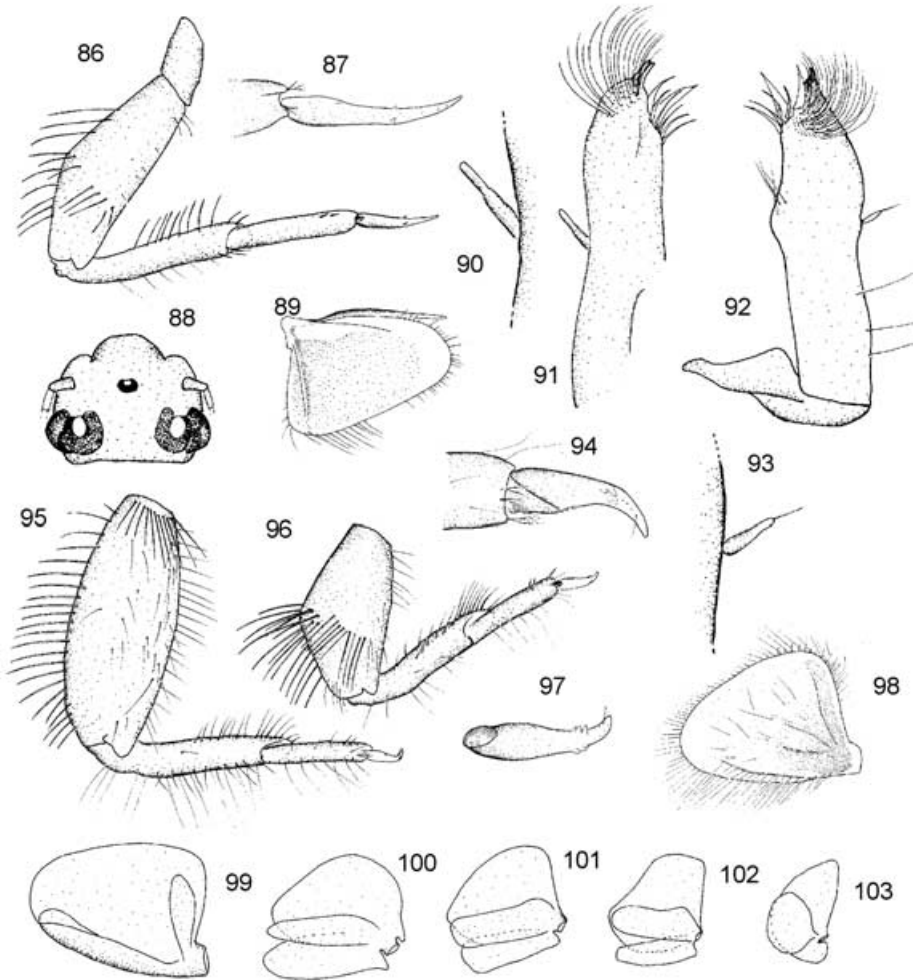

Figures 86–103. Figs. 86–91 *T. ocellus*, nymph: (86) foreleg; (87) fore tarsal claw; (88) head, d.v.; (89) gill II, d.v.; (90) maxillary palp, detail; (91) maxillae. Figs. 92–103 *T. popayanicus*, nymph: (92) maxillae; (93) maxillary palp, detail; (94) fore tarsal claw; (95) hind leg; (96) foreleg; (97) fore tarsal claw; (98) gill II, d.v.; (99) gill II, v.v.; (100–103) gills III–VI, v.v.

*Discussion.* *T. popayanicus* is closely related with *T. yura* sp. nov. (see below). Some drawings are added for comparison: legs and tarsal claws (Figs. 94–97), maxillae (Figs. 92, 93) and gills (Figs. 98–103). *T. popayanicus* can be distinguished from the other species of the genus by the following combination of characters. In the imago: (1) abdominal segments uniformly shaded with greyish-black, except on intersegmental membranes; (2) tibiae and tarsi with blackish subapical marks; (3) femora

without markings or with a greyish subapical band; (4) ratio segment 1/segment 2 of forceps: 0.8–1.2; (5) vein CuP present (similar to Figs. 142, 143). In the nymph: (1) abdominal colour pattern as in imago; (2) opercular gill triangular shaded with black on basal 1/4 (Fig. 98); (3) maxillary palp 2-segmented with apical setae (Figs. 92, 93); (4) transversal row of setae on fore femora: submedian (Fig. 96); (5) tibiae and tarsi without blackish subapical marks; (6) tarsal claws with 2–3 marginal denticles and 2–3 pairs of submarginal denticles (Figs. 94, 97).

*Tricorythodes quizeri* sp. nov. (Figs. 104–123)

*Male imago.* Length: body, 3.5 mm; forewings, 3.5 mm. General coloration whitish-yellow. Head shaded with blackish behind the eyes and on a V-shaped mark between lateral ocelli, ventrally with blackish marks on remnants of labrum, mandibles and labium.

Thorax. Pronotum and propleurae translucent hyaline shaded with blackish-grey, prosternum whitish; mesonotum yellowish shaded with blackish-grey on margins and carinae, between posterolateral scutal protuberances and on mesoscutellum, shaded with grey on a wide mediolongitudinal band; mesopleurae and mesosternum yellowish-white shaded with grey on carinae. Metanotum and metapleurae yellowish-white shaded with blackish-grey, metasternum whitish-translucent. Legs (Fig. 113): fore coxae whitish-brown, meso- and hind coxae yellowish-white, shaded with grey; trochanters yellowish with a blackish apical mark; fore femora shaded with grey on dorsal surface; meso- and hind femora whitish shaded with grey on a subapical mark, hind femora with an additional grey mark near the base; fore tibiae and tarsi translucent shaded with grey, shading more marked on apex of tibiae; meso- and hind tibiae and tarsi whitish, shaded with grey on hind tibiae. Wings (Figs. 105 a,b). Membrane of forewings hyaline slightly tinged with yellowish, shaded with blackish-grey on base of wing and C, Sc and R1 regions, longitudinal veins yellowish, cross veins whitish-translucent. Membranous filaments on mesoscutellum not visible. Abdomen whitish-translucent shaded almost completely with blackish-grey, shading more marked and extended on terga I–II and VII–X; mediolongitudinal line and lateral zones of terga III–VI without shading, whitish as Fig. 106. Abdominal sterna whitish shaded slightly with grey, shaded stronger on lateral margins as Fig. 112. Genitalia (Figs. 107–109): translucent hyaline tinged with yellowish on hind margin and shaded with grey on lateral margins. Caudal filaments whitish-translucent.

*Female imago.* Length: body, 3.0–3.8 mm; forewings, 3.3–4.4 mm. General coloration whitish-yellow. Head, thorax and abdomen (Figs. 106, 112) as in male imago except shaded with black more markedly. Membranous filaments of mesoscutellum short. Legs as in male imago except femora of mesothorax with a subbasal grey band. Wings (Fig. 104) as in male imago except shaded with blackish-grey on veins, not in the membrane of costal area; longitudinal veins yellowish shaded with grey, cross veins whitish-yellow. Caudal filaments whitish-translucent shaded slightly with grey, mainly on the three basal segments.

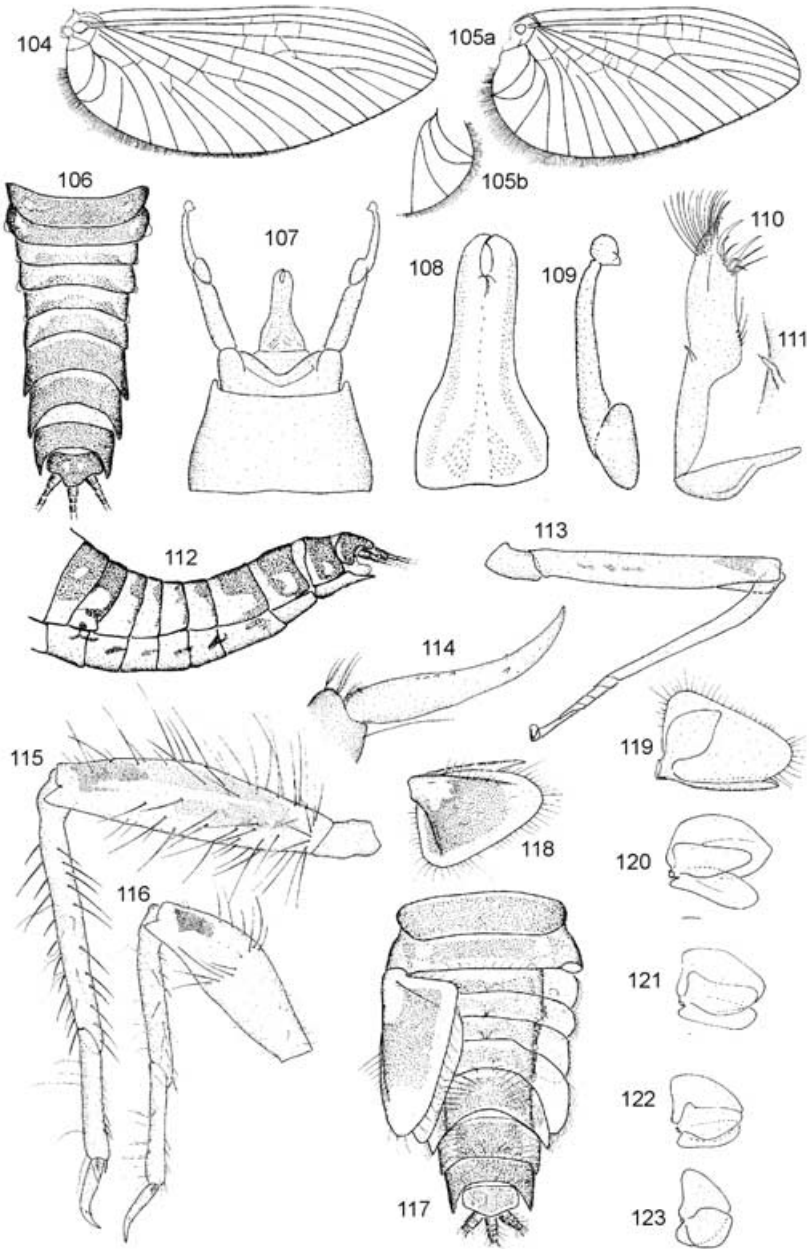

Figures 104–123. *T. quizeri* sp. nov. Imago: (104) female forewing; (105a) male forewing; (105b) variation in Cu area of male forewing; (106) female abdomen, d.v.; (107) male genitalia, v.v.; (108) detail of penes; (109) detail of forceps; (112) female abdomen, l.v.; (113) male mesothoracic leg. Nymph: (110) maxillae; (111) maxillary palp; (114) fore tarsal claw; (115) hind leg; (116) foreleg; (117) abdomen, d.v.; (118) gill II, d.v.; (119) gill II, v.v.; (120–123) gills III–VI, v.v.

*Nymph.* Length: body, 3.8–5.0 mm; mesonotum, 1.5–1.6 mm; hind femora, 0.8–1.0 mm; terminal filament, 2.5–3.2 mm; cerci, 2.0–2.7 mm. General coloration yellowish with blackish marks.

Head shaded with blackish-grey on posterolateral corners of occiput (behind the eyes), on a bigger mark variable in shape between lateral ocelli, on a pair of marks near margins of clypeus, on another submedian pair of marks on labrum and ventrally on mandibles and submentum.

Thorax. Pronotum shaded extensively with black except on anterolateral corners, sterna whitish except lateral and hind margins, light grey. Mesonotum whitish-yellow shaded with blackish-grey except wingpads and a few irregular marks, developing wings whitish with greyish costal margin; mesopleurae shaded with grey, metanotum shaded with blackish except margins, whitish, metasternum whitish shaded with grey. Legs (Figs. 115, 116) yellowish-white with grey marks on coxae and subapex of femora; meso- and hind femora shaded with grey near base; hind tibiae shaded with light grey on the base. Tarsal claws (Fig. 114) with 3–4 marginal denticles and a pair of submarginal denticles near apex.

Abdomen (Fig. 117) whitish completely shaded with blackish-grey, shaded more markedly on gill II and terga I–II and VII–X. Sterna whitish shaded with grey, mainly at margins. Opercular gills (Figs. 118, 119) with whitish zones on base and margins; remaining gills greyish-white (Figs. 120–123). Caudal filaments translucent yellowish-white.

*Observations.* The mature nymphs have whitish wingpads instead of blackish as is common at this stage. The same is described for its sister species, *T. hiemalis*.

*Life cycle associations.* Imagines of both sexes and nymphs from the same locality were associated by shared colour pattern.

*Material.* Holotype male imago from BOLIVIA, road between Santa Cruz and Trinidad, near Once por Ciento, Rio Blanco, 15°21'39.7"S, 63°17'28.8"W, 250 m, 14-IV-2000, E. Domínguez; paratypes: 2 male imagines, 15 female imagines and 10 nymphs, same data as holotype; 15 nymphs from BOLIVIA, Depto. Santa Cruz, Rio Quizer, 10 km NE from San Ramon, 16°29'9.8"S, 62°28'43.8"W, 290 m, 15-VI-2000, E. Domínguez. Holotype, 8 female imagines and 10 nymphs paratypes deposited in UMSA, remaining material in IFML.

*Etymology.* Quizer is one of the rivers where the nymphs were found.

*Discussion.* As mentioned in the discussion of *T. hiemalis*, that species and *T. quizeri* sp. nov. appear as sister species, but they are distinguishable by male genitalia and opercular gill colour pattern. An additional character supporting this sister relationship is the fact that mature nymphs of both species have white wingpads. This character was not included in the analysis because it could not be confirmed with live nymphs of *T. quizeri*. *T. quizeri* can be distinguished from the other species of the genus by the following combination of characters. In the imago: (1) abdominal segments I–II and VII–X shading with grey heavier than segments III–VI (Figs. 106, 112); (2) femora without markings or with a greyish subapical band, tibiae and tarsi without blackish marks (Fig. 113); (3) penes wide at base becoming abruptly narrower in distal half (Figs. 107, 108); (4) ratio segment 1/segment 2 of forceps: 0.9; (5) vein CuP present (Figs. 104, 105); (6) third segment of forceps with a median

projection (Fig. 109). In the nymphs: (1) abdominal colour pattern as in imagines (Fig. 117); (2) opercular gills triangular and blackish, except whitish zone at base (Fig. 118); (3) maxillary palp 2-segmented with apical seta (Fig. 111); (4) transversal row of setae on fore femora: submedian (Fig. 116); (5) tibiae and tarsi without blackish marks (Figs. 115, 116); (6) tarsal claws with 3–4 marginal denticles and a single pair of submarginal denticles (Fig. 114).

***Tricorythodes santarita* Traver (Figs. 124–141)**

*T. santarita* Traver, 1959: 130 (female); Peters, 1981: 216.

*Male imago*. Length: body, 3.0–3.1 mm; forewings, 3.0–3.5 mm.

Head yellowish-white except transverse blackish band on occiput; shaded with grey around antennae.

Thorax. Pronotum whitish-translucent shaded with blackish on lateral zones. Mesonotum whitish-yellow shaded with grey on mediolongitudinal band, except on anteroscutum shaded only on a pair of submedian greyish bands. Mesoscutellum and carinae blackish, membranous filaments not extending beyond apex of mesoscutellum. Metanotum completely shaded with black. Thoracic pleurae and sterna whitish-yellow shaded with grey near the base of wings and legs. Legs yellowish-white, coxae and trochanters shaded with black at margins; femora shaded with reddish-grey at base, apex and broad median band, these bands are interrupted on fore femora; tibiae whitish-translucent with a blackish mark on apex and a broad reddish-grey median band (Fig. 141). Wings (Fig. 124): membrane hyaline, shaded with grey on basal 2/3, mainly on costal margin, distal 1/3 whitish-translucent; longitudinal veins shaded with blackish, cross veins hyaline, except those on Sc and R sectors, shaded with black.

Abdomen. Segments I–VII whitish-translucent, IX–X yellowish-white; terga shaded with black laterally and with reddish-grey medially, similar to Fig. 126. Sterna and genitalia (Fig. 127) translucent yellowish-white. Caudal filaments shaded with grey except at joinings.

*Female imago*. The material studied matches very well with the original description by Traver and available parts of female holotype. A few data need to be added to Traver's description. Length: body, 2.2 mm (abdomen shrunken, without eggs)–3.2 mm (abdomen expanded, full of eggs); forewings, 3.9–4.5 mm. The colour pattern is similar to the male's, except for the blackish shading on the wings, more marked (Fig. 125). The longitudinal vein CuP is fused basally and distally to vein A (Fig. 125a) but some females show other variations (Fig. 125b). Abdomen shaded with black laterally and reddish medially (Fig. 126); lateral margins of segment VIII expanded as in Fig. 130. Caudal filaments whitish-translucent and relatively short, cerci less than 1/4 of wing length and terminal filament less than 1/2 of wing length.

*Nymph*. Length: body, 3.7 mm; mesonotum, 1.3 mm; cerci, 1.2–1.5 mm. General aspect: body depressed, with convex dorsal surface and ventrally concave. General coloration: dorsum covered by whitish, reddish and blackish marks, ventrally pale except femora with colored bands.

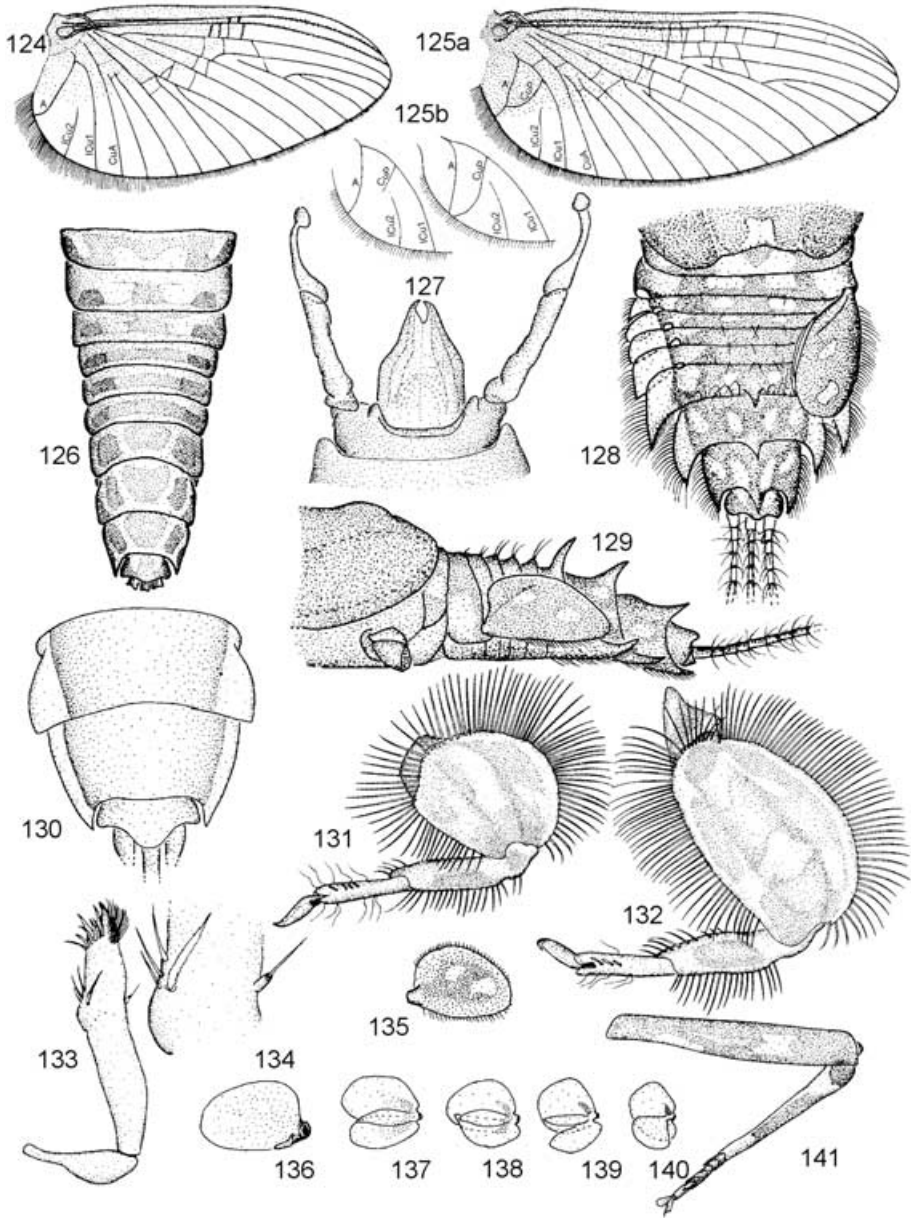

Figures 124–141. *T. santarita*: (124) male forewing; (125a) female forewing; (125b) Cu area variation; (126) female abdomen, v.d.; (127) male genitalia, v.v.; (128) nymphal abdomen, d.v.; (129) nymphal abdomen, l.v.; (130) terga VIII–X of female, holotype. Nymph: (131) foreleg; (132) hind leg; (133) maxillae, d.v.; (134) detail of maxilla, d.v.; (135) gill II, d.v.; (136) gill II, v.v.; (137–140) gills III–VI, v.v.; (141) male imago mesothoracic leg.

Head. Anterior margin with long setae, dorsally blackish except whitish median mark on clypeus and a pair of pale marks near the eyes. Mouthparts: labium shaded with grey on lateral zones, submentum very wide, almost three times mentum width; maxillary palpi 1-segmented with apical seta (Figs. 133, 134).

Thorax. Pro- and mesonotum whitish-yellow shaded almost completely with blackish and reddish, except small paler marks, without pigments; developing wings blackish. Hind margin of mesonotum with a median blunt hump (Fig. 129). Legs: very wide femora, nearly circular and with the margins covered with very long spines (Figs. 131, 132). Ratio width/length of all femora: 0.75. Femora whitish shaded with reddish on a basal and a distal band; a third band is present on median zones of femora II and III. Tibiae and tarsi yellowish with a reddish mark on median zone of tibiae. Tarsal claws without marginal denticles, only with a pair of submarginal denticles near apex (not drawn, not possible to observe due to position on slide).

Abdomen almost as wide as long, all segments very expanded laterally and with lateral margins covered with spines (Fig. 128). Terga II–VI with a pair of short median spines on hind margin, which is elevated. Hind margin of tergum VII with a row of long setae. Long posterolateral spines present on segments VII–IX (Fig. 128). Terga VII–IX each with a big median tubercle (Fig. 129). Terga shaded almost completely with reddish, turning blackish toward lateral zones, except a few paler marks without pigments as in Fig. 128. Gills: opercular gill ovoid (Fig. 135), reddish except a pair of whitish marks on median zone; ventral lamellae of gill II absent except for a small rest of the inferior lamella (Fig. 136). Gills III–V 3-lamellated (Fig. 137–139), gill VI 2-lamellated (Fig. 140). Gills III–VI with a small blackish mark at base. Caudal filaments relatively short, yellowish-translucent, with long setae at joinings.

*Observations.* Body and leg shading varies from blackish to reddish brown, but the colour pattern is always constant. Fore wings of some male imagines are not shaded so markedly with grey.

*Life cycle associations.* Male and female imagines are associated by colour pattern and wing venation. Nymphs and adults are associated by colour pattern on body and legs. Furthermore, some imagines of both sexes, in lateral view, show small remnants of the nymphal median tubercles of abdominal terga VII–VIII.

*Material.* Holotype female imago (body in alcohol, without legs and wings) from URUGUAY, Paysandú, Santa Rita, Puerto de Pepe Ajf, Río Uruguay, 8-XI-1955, C.S. Carbonell col. (FAMU). Other material (IFML): 1 nymph from ARGENTINA, Misiones, Parque provincial Urugua-í, Uruzú stream, 23–24-XI-1998; 15 male and 15 females imagines and 1 nymph from Misiones, Aristóbulo del Valle, Ruta Provincial 7, A° Cuñá-Pirú, 19–20-XI-1998, D., M. & N. (D., M. & N.); also numerous imagines from the following localities in Misiones: Bompland, 18-XI-1998, D., M. & N.; Panambí, 14-II-1985, Domínguez; Parque Provincial Urugua-í, 23–24-XI-1998, D., M. & N.; Río Iguazú (Puerto Canoas), 26-XI-1998, D., M. & N.; confluence of rivers Alegria and Pirai-Guazú, 3–4-XII-1986, Domínguez, 22–23-XI-1998, D., M. & N.; El Soberbio, 21-XI-1998, D., M. & N.; Cerro Azul (A° Mártires), 17-XI-1998, D., M. & N.

*Discussion.* This species was described by Traver from one female imago because its characteristic coloration on wings and legs would easily permit the future association with the males. The holotype is not housed in Facultad de Ciencias de la República

del Uruguay, as indicated on the original description, but in FAMU. The material used in the present redescription fits perfectly the original description and remnants of the holotype. *T. santarita* can be distinguished from the other species of the genus by the following combination of characters: (1) abdomen shaded with blackish and reddish as in Fig. 126; (2) without blackish marks on tibiae or tarsi but with notorious reddish bands on femora and tibiae (Fig. 141); (3) penes wide at base and becoming thinner towards apical 1/3 (Fig. 127); (4) ratio segment 1/segment 2 of forceps: 1.5–1.6; (5) vein CuP may be present, incomplete or absent (Figs. 124, 125); (6) basal 2/3 of wings (Figs. 124, 125) shaded with blackish-grey (in some males this can be reduced to C and Sc areas). In the nymph: (1) body and leg coloration as in Figs. 128, 129 and 131, 132, respectively; (2) opercular gills ovoid, with a pair of paler marks (Fig. 135); (3) maxillary palp 1-segmented with apical seta (Fig. 134); (4) transversal row of spines on fore femora subbasal (Fig. 131); (5) tibiae and tarsi without blackish marks; (6) tarsal claws without marginal denticles, only with a pair of submarginal denticles near the apex; (7) body very depressed and discoidal; (8) very expanded femora, almost as long as wide (Figs. 131, 132); (9) ventral lamellae of gill II absent (Fig. 136) (only a small rest of the inferior lamella is present near the base of the opercular lamella).

As is shown in the cladogram (Fig. 173) *T. santarita* is related to *T. curiosus* (Lugo Ortiz & McCafferty) and *T. nicholsae* (Wang et al.).

***Tricorythodes yura* sp. nov.** (Figs. 142–156)

*Male imago.* Length: body, 2.75–3.00 mm; forewings, 2.70–3.00 mm. General coloration yellowish-white.

Head whitish shaded slightly with grey on occiput and around antennae; antennae yellowish-white.

Thorax. Pronotum yellowish translucent with irregular greyish marks, mesonotum light brown except margins and carinae whitish; metanotum, pleurae and sterna of thorax whitish-yellow; mesoscutellum and membranous filaments hyaline. Legs (Fig. 144): coxae, trochanters and femora whitish tinged with light brown, remaining segments of all legs whitish. Wings (Figs. 142, 143): membrane hyaline shaded slightly with grey on costal margin, veins shaded with grey.

Abdomen whitish-translucent shaded with grey very slightly on terga I and VII–IX. Genitalia (Fig. 145) whitish. Caudal filaments hyaline.

Variations: a few male imagines present a darker coloration with the greyish shading extending on the following zones: basal half of hind femora, mesonotum, thoracic and abdominal sterna, abdominal terga I–IX shaded with grey almost completely except lateral zones of terga IV–VI.

*Female imago.* Length: body, 2.75–3.15 mm; forewings, 3.15–3.35 mm. As in male except usual sexual dimorphism. Egg mass yellowish.

*Nymph.* Length: body, 2.50–2.75 mm; mesonotum 1.0–1.1 mm; caudal filaments, 1.5–2.0 mm. General coloration yellowish-white.

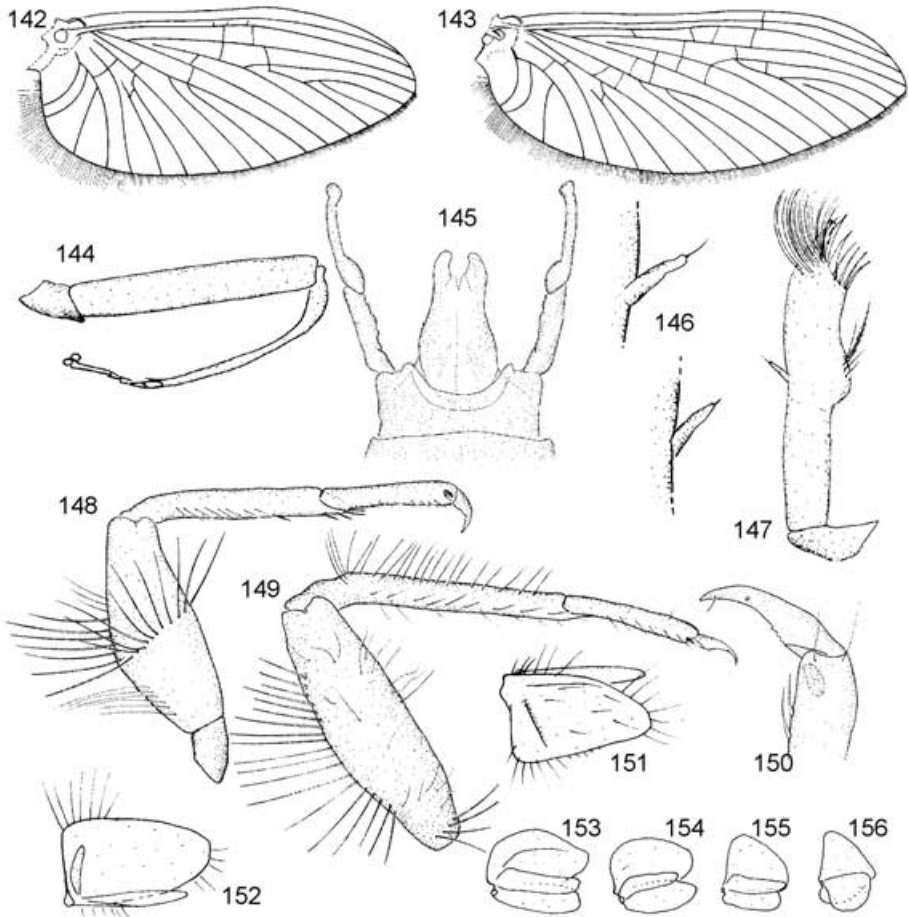

Figures 142–156. *T. yura* sp. nov. Imago: (142) male forewing; (143) female forewing; (144) male mesothoracic leg; (145) male genitalia, v.v. Nymph: (146a–b) details of maxillary palpi; (147) maxillae; (148) foreleg; (149) hind leg; (150) fore tarsal claw; (151) gill II, d.v.; (152) gill II, v.v.; (153–156) gills III–VI, v.v.

Head shaded slightly with light grey as an irregular net on the occiput; mouthparts whitish; antennae yellowish-translucent.

Thorax. Pro- and mesonotum light yellow with light grey marks on mesoscutum and on costal margin of wingpads; metanotum, pleurae and sterna of thorax, whitish (Figs. 148, 149). Legs whitish-yellow without shading. Tarsal claws with 3 marginal denticles and a pair of submarginal denticles near apex (Fig. 150). Abdomen whitish slightly shaded with grey on terga VIII–IX; segments III–VII laterally expanded (slightly on VII), posterolateral spines present on segments VII–VIII. Opercular gill (Figs. 151, 152) triangular, whitish-translucent shaded slightly with grey near base;

remaining gills (Figs. 153–156) hyaline translucent. Caudal filaments yellowish-white translucent with whorls of long setae at joinings.

*Observations.* All the nymphs are covered with small particles of sediment sticking to the long setae of the body, legs and caudal filaments, making the observation of colour marking very difficult without a previous cleaning.

*Life cycle association.* Male and female imagines are associated by shared colour pattern and hour of flight. Nymphs and adults are associated by a reared male.

*Material.* Holotype male imago from BOLIVIA, Dept. La Paz, Stream between Caranavi and Guanai, 15°40'16"S, 67°42'04"W, 500 m, light 4–6 AM, 28-XI-2000, D., M. & N. cols. Paratypes: 24 male and 40 female imagines, 1 reared male and 27 nymphs, same data as holotype. Holotype, 12 male and 20 female imagines and 13 nymphs paratypes deposited in UMSA, remaining material in IFML.

*Etymology.* The specific epithet is an allusion to the pale coloration of nymphs and adults, “yura” is the Quechua word for “white”.

*Discussion.* *T. yura* sp. nov. can be distinguished from the other species of the genus by the following combination of characters. In the imago: (1) abdomen shaded very slightly with grey, mainly in terga I and VII–IX; (2) femora, tibiae and tarsi without blackish marks (Fig. 144); (3) penes as in Fig. 145; (4) ratio length of segment 1/segment 2 of forceps: 1.1–1.2; (5) vein CuP present (Figs. 142, 143). In the nymph: (1) abdomen as in imago; (2) opercular gill triangular shaded with grey only at base (Fig. 151); (3) maxillary palp 2-segmented with apical seta (Fig. 146); (4) transversal row of setae on fore femora submedian (Fig. 148); (5) tibiae and tarsi without blackish marks; (6) tarsal claws with 3–4 marginal denticles and 1 pair of submarginal denticles near apex (Fig. 150).

*T. yura* is very similar to *T. popayanicus* Domínguez, and in the phylogeny presented here both are sister species. They can be separated by colour pattern and tarsal claw denticulation.

### *Tricorythodes zunigae* sp. nov. (Figs. 157–172)

*Male imago.* Length: body, 3.0 mm; forewings, 3.0 mm. General coloration yellowish with a longitudinal black band along thorax and abdomen (Fig. 159).

Head yellowish tinged completely with reddish-pink; antennae whitish shaded with grey behind compound eyes and on rest of mouthparts.

Thorax. Pronotum yellowish-translucent shaded with black dorsally, except median zone (Fig. 159). Meso- and metanotum yellowish, mesonotum shaded with black on a mediolongitudinal band, this band wider just before mesoscutellum, which is not shaded (Fig. 159). Thoracic pleurae and sterna yellowish tinged slightly with reddish-pink. Legs (Fig. 160) whitish, femora completely tinged with reddish-pink and shaded with grey on a subbasal transverse band; tibiae tinged with reddish-pink on median zone. Wings (Fig. 158): membrane hyaline, longitudinal veins yellowish, cross veins whitish-translucent.

Abdomen whitish with a broad longitudinal black band extending from segments I to IX (Fig. 159); tinged with reddish-pink on tergum X, lateral zones of terga

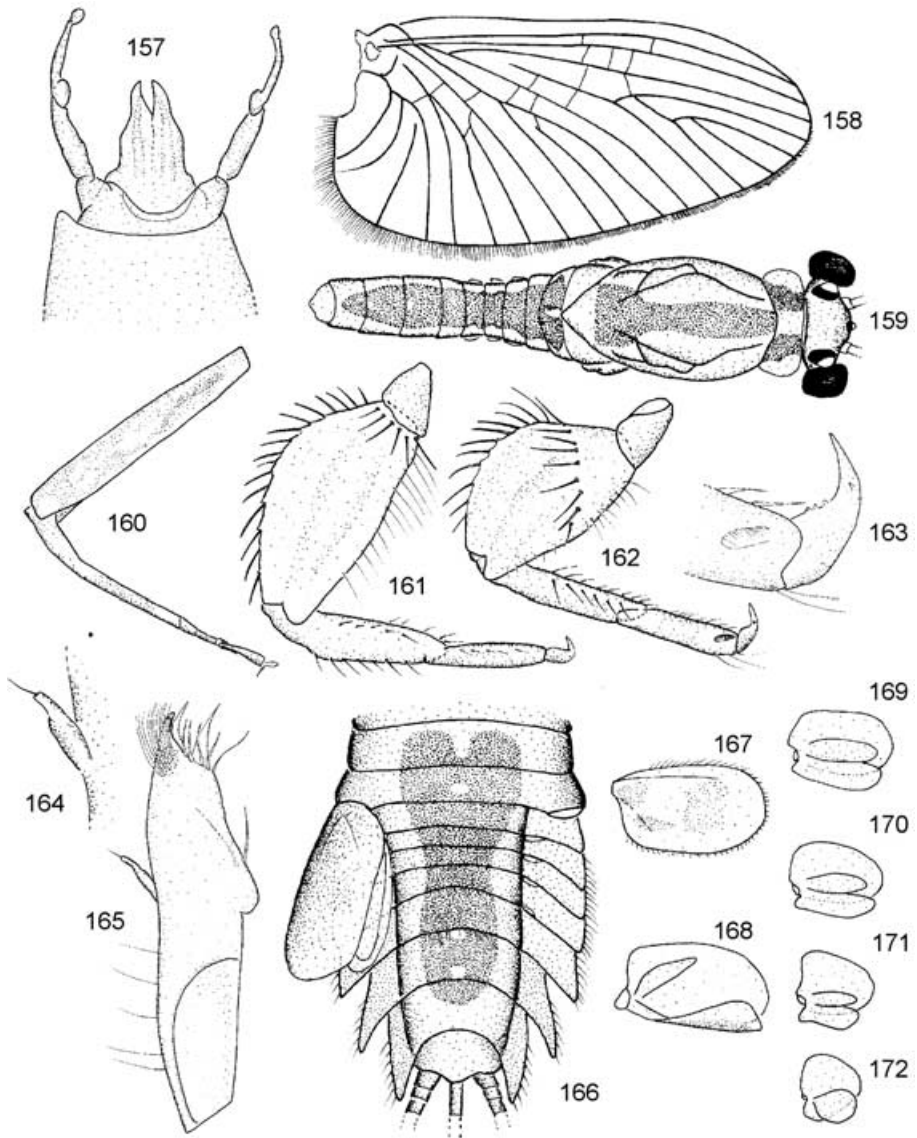

Figures 157–172. *T. zunigae* sp. nov. Imago: (157) male genitalia, v.v.; (158) forewing; (159) dorsal aspect of male (wings and legs omitted); (160) male mesothoracic leg. Nymph: (161) hind leg; (162) foreleg; (163) tarsal claw; (164) maxillary palp; (165) maxilla, v.v.; (166) abdomen, d.v.; (167) gill II, d.v.; (168) gill II, v.v.; (169–172) gills III–VI, v.v.

VIII–IX and pleural folds of segments II–III and VII–IX. Genitalia (Fig. 157) whitish. Caudal filaments whitish-translucent.

*Nymph.* Length: body, 2.0 mm; caudal filaments, 2.0 mm. General aspect discoidal.

Head yellowish-white, tinged diffusely with reddish-pink on dorsum and shaded with greyish-black behind the eyes; genal projections present, frontal shelf absent; maxillary palp 2-segmented with apical setae (Figs. 164, 165).

Thorax yellowish-white, paler ventrally; anterolateral corners of pronotum acute and directed anteriorly, pro- and mesonotum shaded with black as in male imago (Fig. 159); mesonotum with a pair of small circular reddish marks at the base of wingpads; metanotum without blackish marks tinged slightly with reddish-pink. Legs (Figs. 161, 162) yellowish-white tinged with reddish-pink on femora and base of tibiae; femora wide and discoidal, fringed with long spines; tarsal claws (Fig. 163) with 3–4 marginal denticles and 1 pair of submarginal denticles near apex.

Abdomen (Fig. 166). Terga yellowish with a black longitudinal band extending from segment I to anterior half of IX; abdominal segments III–IX with strongly laterally expanded margins; abdominal sterna pale, translucent. Gills: opercular gills (Figs. 167, 168) quadrate-ovoid, yellowish-translucent tinged with reddish mainly at base, remaining gills (Figs. 169–172) whitish-translucent. Caudal filaments yellowish-translucent.

*Life cycle association.* Male and nymph from the same locality are associated by a shared colour pattern on body and legs.

*Material.* Holotype male imago (wing, legs and genitalia on slide) and paratype nymph (mouthparts and legs on slide, gills dissected) from COLOMBIA: Chocó, Municipio de Acandí, Serranía de Tripogadí, Quebrada Coquitral, 08°23'58"N, 77°08'46"W, 115 m, 17–19-VII-1999, M. C. Zúñiga, M.P. Rozo and C. Camargo cols. Deposited in MEUV.

*Etymology.* This species is dedicated to María del Carmen Zúñiga de Cardoso (Universidad del Valle, Cali, Colombia), who made extensive collections in Colombia and kindly offered the present material to be included in this study.

*Discussion.* *T. zunigae* sp. nov. can be distinguished from the other species of the genus by the following combination of characters. In the imago: (1) abdomen shaded with blackish on a broad mediolongitudinal band as in Fig. 159; (2) without blackish marks on tibiae or tarsi but with reddish-pink bands on femora and tibiae (Fig. 160); (3) penes wide at base and becoming thinner on apical 1/3 (Fig. 157); (4) ratio segment 1/segment 2 of forceps: 1.1; (5) vein CuP present (Fig. 158); (6) membrane of wings shaded with blackish-grey in C and Sc areas. In the nymph: (1) body and leg coloration as in Figs. 166 and 161, 162, respectively; (2) opercular gills subquadrate-ovoid (Fig. 167); (3) maxillary palp 2-segmented with apical seta (Fig. 164); (4) transversal row of spines on fore femora subbasal (Fig. 162); (5) tibiae and tarsi without blackish marks; (6) tarsal claws with 3–4 marginal denticles and with a pair of submarginal denticles near the apex (Fig. 163); (7) body discoidal very depressed; (8) very expanded femora, almost as long as wide (Figs. 161, 162). As is shown in the cladogram (Fig. 173) *T. zunigae* is related to the *T. santarita* species group and can be distinguished from the other species of this group by its characteristic colour

pattern (Figs. 159, 166), absence of abdominal tubercles (Fig. 166), opercular gill subquadrate (Fig. 167) and maxillary palp relatively long (Figs. 164, 165).

**Cladistic Analysis**

A matrix of 17 taxa and 28 characters (Table 1) was analyzed using the program PIWE (Goloboff, 1993a), which applies the principle of parsimony under implied weights (theoretical justification can be found in Goloboff, 1993b). All characters are treated as additive except characters 4, 20, 25 and 26 which are treated as non-additive because it was impossible to set a logical sequence of change between character states.

The tree search was made using the command “mult\*” which randomises the order of the taxa, creates a weighted Wagner tree and then does TBR (Tree Bisection Reconnection) keeping the better trees. A set of 10 replications of this process did not find additional trees (the same happens with 20 and 50 replications). The results were analyzed and printed using the program Winclada (Nixon, 1986–1999).

*Outgroup/ingroup selection.* No previous cladistic analysis has been made within Leptohiphidae, so the relationships between the genera of the family are still unknown. In the present analysis the tree was rooted independently with *Haplohy-*

Table 1. Matrix: 17 taxa, 29 characters. Unknown states = -. Underlined taxa = new species, taxa marked \* = new combinations.

	1	2
	1234567890123456789012345678	123456789012345678
<i>Haplohyphes</i>	00000000000000000000	1200000000
<i>Leptohiphodes</i>	0000000001011002010300002222	
<i>T. arequita</i>	1100111010011001010101211100	
<i>T. australis</i>	100411100—	
<i>T. barbatus</i>	1—000000000001100111000	
<i>T. bullus</i>	1101211001101022020001321011	
<i>T. cristatus</i>	1—0011—02—02000—10—	
<i>L. curiosus*</i>	11—2211102011022120102312121	
<i>T. hiemalis</i>	1103111000000011010101211001	
<i>T. mirca</i>	1100111010011001010101211100	
<i>L. nicholsae*</i>	1—1102011132120—123221—	
<i>T. ocellus</i>	1—00100001—01110—110—	
<i>T. popayanicus</i>	1100111001000011010201211211	
<i>T. quizeri</i>	1103111000001011010101211001	
<i>T. santarita</i>	1112211102011122121112332122	
<i>T. yura</i>	11001110010—01—010101211211	
<i>T. zunigae</i>	1102211102001011120102312121	

*phes* or *Leptohiphes*, without changes on the results. The character states of both taxa were coded from reared material of *H. furtiva* Domínguez, 1984 and *L. eximius* Eaton, 1883–1888 (Molineri, in press), respectively.

Finally, the tree was rooted on *H. furtiva*, including *L. eximius* with the ingroup to test the position of two species erroneously described as *Leptohiphes*: *L. curiosus* and *L. nicholsae*. The remaining species included are: *T. arequita*, *T. australis*, *T. mirca*, *T. barbus*, *T. bullus*, *T. cristatus*, *T. hiemalis*, *T. ocellus*, *T. popayanicus*, *T. quizeri*, *T. santarita*, *T. yura* and *T. zunigae*. Only the South American species of *Tricorythodes* were included in the analysis due to material availability.

#### Adult characters:

##### Wings

- 1 Hind wings: 0 = present, 1 = absent

##### Male genitalia

- 2 Basal swelling on second segment of forceps: 0 = absent, 1 = present (Fig. 5)  
 3 Relative length of forceps' segments 1 and 2: 0 = segment 1 shorter or subequal than segment 2 (Fig. 5), 1 = segment 1 more than 50% longer (Fig. 127)  
 4 Form of penes (non-additive): 0 = plate-like (Fig. 5), 1 = pyramidal (Fig. 40), 2 = narrowing slightly on apical 1/3 (Fig. 127), 3 = narrowing abruptly on apical 1/2 or 2/3 (Fig. 108), 4 = "australis"-type (Figs. 21, 22)  
 5 Median lobes of penes (additive): 0 = present, 1 = reduced (Fig. 5), 2 = absent (Figs. 22, 40)  
 6 Fusion of penes: 0 = basal half, 1 = almost completely fused

##### Female

- 7 Female cerci: 0 = longer than forewings, 1 = shorter than wings

##### Colour markings (adults and nymphs)

- 8 Colour markings on femora: 0 = subapical grey band (Fig. 4), 1 = 2 or 3 transverse reddish bands strongly marked (Fig. 141)  
 9 Subapical blackish marks on tibiae and tarsi: 0 = absent, 1 = present (Figs. 4, 11, 12)

##### Nymphal characters:

- 10 General shape of body (additive): 0 = elongated, 1 = stout, 2 = very depressed, circular outlining  
 11 Tubercles on head and thorax: 0 = absent, 1 = present (Figs. 42, 57)

##### Head and mouthparts

- 12 Genal projections: 0 = present, 1 = absent  
 13 Frontal shelf: 0 = present, 1 = absent  
 14 Maxilla (relative length of stipes and galeolacinia): 0 = stipes shorter or subequal than galeolacinia (Fig. 8), 1 = stipes longer than galeolacinia (Fig. 133)  
 15 Maxillary palp (number of segments) (additive): 0 = 3 segments, sometimes with an apical seta (Figs. 9, 29), 1 = 2 segments and apical seta (Figs. 90, 111), 2 = 1 segment and apical seta (Fig. 43), 3 = palp absent

##### Thorax and legs

- 16 Projections on anterolateral corners of pronotum (additive): 0 = big, 1 = medium size, 2 = absent  
 17 Width of femora: 0 = thin (maximum width less than 40% of maximum length, Figs. 12, 27), 1 = wide (max. width more than 50% of max. length, Figs. 131, 132)  
 18 Position of transverse row of setae on fore femora (additive): 0 = subdistal (Fig. 27), 1 = submedian (Fig. 12), 2 = subbasal (Figs. 55, 62, 131)  
 19 Tarsal claw (marginal denticles): 0 = present (Fig. 10), 1 = absent (Fig. 24)  
 20 Tarsal claw (submarginal denticles, near apex) (non-additive): 0 = absent (Fig. 56), 1 = 1 pair (symmetric, Fig. 24), 2 = 3 or more denticles distributed in two asymmetrical rows (Fig. 97), 3 = 1 denticle (asymmetric)

Abdomen and gills

- 21 Tubercles on abdomen: 0 = absent, 1 = present (Fig. 129)
- 22 Abdominal segments laterally expanded (additive): 0 = segments III–VI (Fig. 25), 1 = III–VII (Fig. 77), 2 = III–VIII (Fig. 128)
- 23 Posterolateral spines on abdominal segments (additive): 0 = absent, 1 = present on segment VII, 2 = on VII–VIII, 3 = on VII–IX
- 24 Gill formula (number of lamellae per gill, gills II, III, IV, V, VI) (additive): 0 = 3-4-4-4-2 or more, 1 = 3-3-3-3-2 (Figs. 14–18), 2 = 2-3-3-3-2 (Figs. 49–53), 3 = 1-3-3-3-2 (Figs. 136–140)
- 25 Shape of opercular gill (non-additive): 0 = subtriangular, 1 = triangular (Fig. 13), 2 = ovoid (Fig. 135)
- 26 Pigments on opercular gills (non-additive): 0 = extense and uniformly distributed (Fig. 31), 1 = extense and irregularly distributed (Figs. 13, 80), 2 = restricted to base of gill (Fig. 98)
- 27 Dorsal angle of ventral lamella of gills of segments III–V (Figs. 33, 34) (additive): 0 = well developed (Figs. 33–35), 1 = slightly developed (Figs. 50–52), 2 = absent (67–69, 137–139)
- 28 Basal extension of dorsal lamellae of gills of segments III–V (Figs. 33, 34) (additive): 0 = well developed (Figs. 33–35), 1 = slightly (Figs. 50–52), 2 = absent (Figs. 137–139)

**Results and Discussion**

Only one tree was obtained, shown in Fig. 173. The tree has two unresolved nodes: one at the base of the ingroup (node A) with the trichotomy (*T. australis* + *T. barbus* + remaining species of *Tricorythodes*). This situation is due to the unknown adult

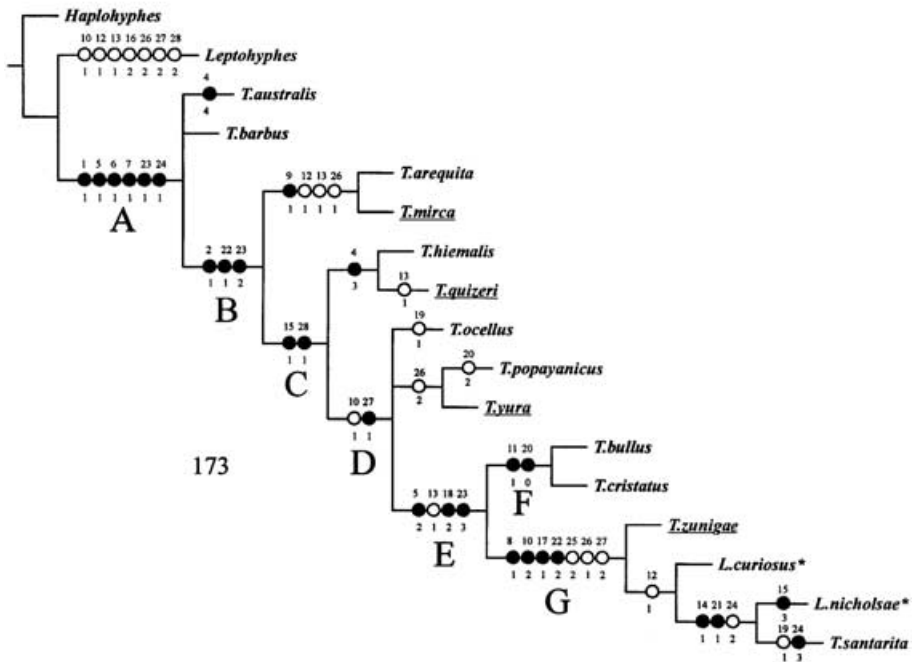

Figure 173. Cladogram, unsupported nodes collapsed. Taxa marked with \* are here transferred to *Tricorythodes*. Taxa underlined are new species. Black hashmarks = synapomorphies, white = reversions/parallelisms.

characters of *T. barbatus* (which has a typical *Tricorythodes* nymph) and the unknown nymphal characters of *T. australis* (doubtfully a *Tricorythodes*).

The second unresolved node (node D) is mainly due to the missing characters of *T. ocellus*, known only from nymphs.

The character "Vein CuP on forewings (non-additive): 0 = entire (reaching posterior margin of wing, Fig. 1), 1 = incomplete (Figs. 37, 125), 2 = absent (Fig. 23)" was first included in the analysis but because it shows variations even in single individuals of some species and as a result was uninformative, it was finally excluded.

Node A is supported by the following synapomorphies: hind wings absent (char. 1: state 1), median lobes of penes reduced (5: 1), penes almost completely fused (6: 1), female cerci shorter than body (7: 1), posterolateral spines present on abdominal segment VII (23: 1), number of lamellae on each abdominal gill: 3-3-3-3-2 (24: 1).

Node B, where *T. barbatus* is not included by missing codes on adult characters, is supported by the basal swelling on the second segment of the forceps (2: 1) among others character states. This character on male genitalia is the most commonly used to define the genus for its easy observation and constancy within *Tricorythodes*, so it is thought that adults of *T. barbatus* will show this character. On the other hand *T. australis* does not have this synapomorphic character and here is for the time being maintained in *Tricorythodes* because nymphs are still unknown.

Some nodes are supported by numerous characters, for example node G (*T. zunigae* (*L. curiosus* (*L. nicholsae* + *T. santarita*))) supported by the following synapomorphies: femora almost completely pigmented, with 2–3 strong bands (8: 1), general body form of nymph (10: 2), femora wide (17: 1), abdominal segments III–VIII laterally expanded (22: 2), a few parallelisms: pigmentation of opercular gill extense and irregular (26: 1), dorsal extension on ventral lamellae of gills III–V absent (27: 2) and a reversal: ovoid opercular gills (25: 2). The cladistic analysis shows many characters supporting the new combinations here proposed for *Leptohyphes curiosus* Lugo-Ortiz and McCaferty (1995) and *L. nicholsae* Wang et al. (1998) and suggests that new species of these groups should be described from all stages to avoid mistakes.

Node E (group formed by the *T. santarita* species group together with *T. bullus* + *T. cristatus*) is also supported by numerous synapomorphies: median lobes of penes absent (char. 5: state 2), subbasal position of transversal row of seta on fore femora (18: 2), posterolateral spines present on abdominal segments VII–IX (23: 3), and a parallelism: frontal shelf absent (13: 1). Other groups supported are the pairs of species: (*T. arequita* + *T. mirca*), (*T. hiemalis* + *T. quizeri*) and (*T. popayanicus* + *T. yura*).

In 1987 Allen and Murvosh proposed three subgenera within *Tricorythodes*: *Tricorythodes* s.s., *Tricoryhyphes* and *Homoleptohyphes* Allen and Murvosh. These authors included in the subgenus *Tricorythodes*, among other species: *T. barbatus* Allen, *T. bullus* Allen, *T. cristatus* Allen and *T. ocellus* Allen & Roback. From the cladistic analysis it is evident that this subgenus is polyphyletic (Fig. 173).

The subgenus *Tricorythyphes* was erected for *T. condylus* Allen, and the authors suggested that *T. popayanicus* may also be included. Domínguez (pers. comm.) noted that *T. popayanicus* does not have all the character states of *Tricorythyphes*. As *T. condylus* was not included in the present analysis, no conclusion about the validity of the subgenus can be drawn. None of the species included by Allen and Murvosh in the subgenus *Homoleptohiphes* were studied.

*Tricorythyphes* sensu Wiersema and McCafferty (2000) (*T. barbatus* + *T. ocellus* + *T. popayanicus*) is clearly polyphyletic in the present analysis. *Asioplax* and *Epiphrales* Wiersema and McCafferty (nodes F and G in the present analysis, respectively) appear only as apomorphic species groups of *Tricorythodes*, and keeping its previous generic assignment in *Tricorythodes* Ulmer is certainly necessary, especially because giving them generic status as these authors propose would force to give the same level to all the other monophyletic groups between node E and the root, what seems not convenient in the present state of knowledge.

For these reasons the genus *Tricorythodes* is treated as a single unit until a better understanding of the species relationships can justify its subdivision.

A generic key for the Leptohiphidae was published elsewhere (Molineri, 1999) and is not included here, but a combination of characters is proposed to distinguish the South American species of *Tricorythodes* from the other genera of Leptohiphidae. Adults: (1) hind wings absent; (2) membranous filaments on mesoscutellum present, short, extending or not above metanotum; (3) vein ICu1 joined basally with vein A forming a triad where veins CuP and ICu2 are included; (4) second segment of forceps with a basal swelling (except *T. australis*); (5) penes of male broad and almost completely fused; (6) terminal filament of female imago covered by small setae and longer than cerci, cerci bare and shorter than body. Nymphs: (1) maxillary palp reduced in size, with 3, 2 or 1 segment almost always with an apical seta; (2) genal and frontal projections present (independently lost in some species); (4) hind wingpads absent in both sexes; (5) opercular gills triangular (except one group of species with a secondarily reduced, ovoid opercular gill); (6) abdominal gill formula (number of lamellae on gills II, III, IV, V, VI): 3-3-3-3-2 (independently reduced in few species).

### Key to the South American species of *Tricorythodes*

Note: In the following key two species described in *Tricorythodes* are not included: *T. australis* and *T. lichyi* Traver. *T. australis* does not have the diagnostic characters of the genus and can easily be separated from the other species of *Tricorythodes* by the characters listed in its "Discussion". Material of *T. lichyi* was not studied and the original description is not sufficient to distinguish it from the other species, but because Traver described the presence of blackish marks on the subapex of tibiae it may be related to the *T. arequita* species group. Due to the large number of undescribed species, identifications from the following key should be confirmed with specific descriptions and drawings, as well as with geographic distribution.

## Imagines

- 1 Tibiae whitish with notorious blackish subapical marks (Figs. 4, 73) ..... 2
- Tibiae without subapical blackish marks (Figs. 44, 113, 141, 144, 160) ..... 3
- 2 Blackish subapical marks present on tibiae and tarsi (Fig. 4) ..... *T. arequita* Traver
- Blackish subapical marks present only on tibiae (Fig. 73) ..... *T. mirca* sp. nov.
- 3 Femora of all legs with 2 or 3 reddish or greyish transverse bands (Fig. 141, 160) ..... 4
- Femora without strong marks or with a subapical greyish band, sometimes more extended but never as above (Figs. 44, 113, 144) ..... 5
- 4 Forewings shaded with black on basal 1/3 (Figs. 124, 125) (S Brazil, N Uruguay and NE Argentina) ..... *T. santarita* Traver
- Forewings shaded with black only on costal margin (Fig. 158) (Colombia) ..... *T. zunigae* sp. nov.
- 5 Penes abruptly narrowed on distal half, as in Figs. 107, 108 ..... 6
- Penes pyramidal or plate like (Figs. 40, 145), never as above ..... 7
- 6 Penes divided on apical 1/5; penes 1.5 times longer than its basal width ..... *T. hiemalis* Molineri
- Penes divided on apical 1/6; penes 2 times longer than its basal width (Figs. 107, 108) ..... *T. quizeri* sp. nov.
- 7 Vein CuP of forewings entire, reaching posterior margin of wing (Figs. 142, 143) (NW of Argentina and Bolivia) ..... 8
- Vein CuP of forewings generally incomplete, not reaching hind margin of wing (Figs. 37, 38) (NE Argentina, S of Brazil and N of Uruguay) ..... *T. bullus* Allen
- 8 Abdominal segments shaded with grey except on intersegmental membranes; penes without marked constrictions ..... *T. popayanicus* Domínguez
- Abdominal segments almost without shading; penes with a subapical constriction (Fig. 145) ..... *T. yura* sp. nov.

## Nymphs

- 1 Body very depressed and discoidal; femora almost circular and fringed with very long spines (Figs. 131, 132); opercular gills ovoid or subquadrate (Figs. 135, 167) ..... 2
- Body not so depressed; femora slender (Figs. 11, 12, 27, 28, 46, 47); opercular gills triangular (Figs. 13, 31, 48) ..... 4
- 2 Abdominal tubercles absent; colour pattern as in Fig. 166 (Colombia) ..... *T. zunigae* sp. nov.
- Abdominal tubercles present (Figs. 128, 129); colour pattern not as above ..... 3
- 3 Abdomen with median tubercles on terga 7–9 (Figs. 128, 129) (S Brazil, N Uruguay and NE Argentina) ..... *T. santarita* Traver
- Abdomen with median tubercles on terga 3–9, bigger on terga 6–9 (Ecuador) ..... *T. nicholsae* (Wang et al.) comb. nov.
- 4 Dorsal tubercles present on head, pronotum and mesonotum (Figs. 42, 57) ..... 5
- Without tubercles on head or thorax ..... 6
- 5 Tubercles big and acute in lateral view (Fig. 42); abdominal colour pattern as in Fig. 41 ..... *T. bullus* Allen
- Tubercles small and blunt, slightly elevated above head and thorax (Fig. 57)\* ..... *T. cristatus* Allen
- 6 Opercular gill whitish or yellowish shaded with grey or black only at base (Figs. 98, 151) ..... 7
- Opercular gill almost completely shaded with grey or black (Figs. 13, 31, 80, 89, 118) ..... 8
- 7 Opercular gill shaded with black on basal 1/4 (Fig. 98); tarsal claws with more than 1 pair of submarginal denticles near apex (Figs. 94, 97) ..... *T. popayanicus* Domínguez
- Opercular gill shaded with grey only on a transverse basal line (Fig. 151); tarsal claws with 1 pair of submarginal denticles near apex (Fig. 150) ..... *T. yura* sp. nov.
- 8 Tibiae and tarsi whitish with notorious subapical blackish marks at least on tibiae (Figs. 11, 12, 75, 76); colour pattern formed by small pigmented marks distributed irregularly (Figs. 3, 6, 77) ..... 9
- Tibiae and tarsi without these marks (Figs. 27, 28, 86, 115, 116); colour pattern formed by uniformly distributed pigmentation (Figs. 25, 106, 117) ..... 10
- 9 Maxillary palp 3-segmented (Fig. 9); big blackish marks present on tibiae and tarsi (Figs. 11, 12) ..... *T. arequita* Traver

\**T. cristatus*: abdominal colour pattern is not adequately described by Allen, and bodies of the paratypes were not available for study.

- Maxillary palp 2-segmented with an apical seta (Fig. 78b); blackish marks present on tibiae only (Figs. 75, 76) ..... *T. mirca* sp. nov.
- 10 Lateral ocelli large, almost as large as compound eyes (Fig. 88) ..... *T. ocellus* Allen & Roback
- Lateral ocelli small, at least 40% smaller than compound eyes (Fig. 26) ..... 11
- 11 Abdominal segments 3–6 expanded laterally (Fig. 25), posterolateral spines present on abdominal segment 7; tarsal claws without marginal denticles, only one pair of submarginal denticles near apex (Fig. 24) ..... *T. barbatus* Allen
- Abdominal segments 3–7 expanded laterally (Fig. 117), posterolateral spines present on abdominal segment 7–8; tarsal claws with 4–5 marginal denticles and one pair of submarginal denticles near apex (Fig. 114) ..... 12
- 12 Opercular gill shaded completely with blackish; frontal projection present ..... *T. hiemalis* Molineri
- Opercular gill shaded completely with blackish except at anterolateral corner (Figs. 117–118); frontal projection absent ..... *T. quizeri* sp. nov.

## Acknowledgements

I am grateful to Enrique Morelli (Facultad de Ciencias de la República, Uruguay), Jan Peters (Florida A&M University, Tallahassee, USA) and Wojciech J. Pulawski (California Academy of Sciences) for the loan of the type material deposited at each institution. E. Domínguez made numerous useful suggestions for the improvement of the manuscript. I also want to acknowledge the “Dirección Técnica Regional Nordeste de Parques Nacionales” and “Ministerio de Ecología de la Provincia de Misiones” for the collect permits issued. The “Instituto de Ecología de la Universidad Mayor de San Andrés, La Paz, Bolivia” kindly offered the Bolivian material to be included in this paper. Economical support for this investigation was provided by the following grants: CONICET PIA 8019/96, PIP 4973/97 and FONCyT 0100692/97 (ANPCyT) and by an internal fellowship from Conicet (National Council of Scientific Research, Argentina).

## References

- Allen RK (1967): New species of New World Leptohiphinae (Ephemeroptera: Tricorythidae). *Can Entomol* 99: 350–375.
- Allen RK, Murvosh CM (1987): Mayflies (Ephemeroptera: Tricorythidae) of the Southwestern United States and Northern Mexico. *Ann Entomol Soc Amer* 80: 35–40.
- Allen RK, Roback SS (1969): New species and records of New World Leptohiphinae (Ephemeroptera: Tricorythidae). *J Kansas Entomol Soc* 42: 372–379.
- Banks N (1913): Neuropteroid insects from Brazil (The Stanford Expedition to Brazil, 1911). *Psyche* 20: 83–89.
- Domínguez E (1982): Una especie nueva de Tricorythidae de la Argentina (Insecta: Ephemeroptera). *Rev Soc Entomol Argent* 41: 331–335.
- Domínguez E (1984): Dos especies nuevas del género *Haplohyphes* Allen (Ephemeroptera: Tricorythidae) de la Argentina. *Rev Soc Entomol Argent* 43: 103–112.
- Domínguez E, Hubbard MD, Pescador ML (1994): Los Ephemeroptera en Argentina. *Fauna Agua Dulce Rep Argent* 33(1): 1–142.

- Eaton AE (1883–1888): A revisional monograph of recent Ephemeridae or mayflies. *Trans Linn Soc London* (II) 3: 1–352.
- Goloboff PA (1993a): Computer software. Parsimony and Implied Weights—version 2.9. © 1993–1997.
- Goloboff PA (1993b). Estimating character weights during tree search. *Cladistics* 9: 83–91.
- Lugo Ortiz CR, McCafferty WP (1995): Contribution to the taxonomy of the Leptohiphidae (Insecta: Ephemeroptera) of Central America. *Stud Neotrop Fauna Environ* 30(3): 165–176.
- Nixon KC (1986). Computer software. Winclada. © 1986–1999.
- Molineri C (1999): Revision of the genus *Tricorythopsis* (Ephemeroptera: Leptohiphidae) with the description of four new species. *Aquat Insect* 21: 285–300.
- Molineri C (2001): Una especie nueva de *Tricorythodes* (Ephemeroptera: Leptohiphidae) de la Argentina con notas sobre su biología. *Rev Soc entomol Argent* 60: 61–66.
- Molineri C (in press): Revision of the South American species of *Leptohiphes* Eaton (Ephemeroptera: Leptohiphidae) with a key to the nymphs. *Stud Neotrop Fauna Environ*, in press.
- Peters WL (1981): *Coryphorus aquilus*, a new genus and species of Tricorythidae from the Amazon basin (Ephemeroptera). *Aquat Insect* 3: 209–217.
- Roback SS (1966): The Caterwood Foundation Peruvian-Amazon Expedition. VI. Ephemeroptera nymphs. *Monog Acad Nat Sci Phila* 14: 129–199.
- Traver JR (1958): The subfamily Leptohiphinae (Ephemeroptera: Tricorythidae). Part I. *Ann Entomol Soc Amer* 51: 491–503.
- Traver JR (1959): The subfamily Leptohiphinae. Part II: Five new species of *Tricorythodes* (Ephemeroptera: Tricorythidae). *Proc Entomol Soc Wash* 61: 121–131.
- Ulmer G (1920): Neue Ephemeropteren. *Arch Naturgesch* 85A(11): 1–80.
- Wang TQ, Sites RW, McCafferty WP (1998): Two new species of *Leptohiphes* (Ephemeroptera: Leptohiphidae) from Ecuador. *Florida Entomol* 81:68–75.
- Wiersema NA, McCafferty WP (2000): Generic revision of the North and Central American Leptohiphidae (Ephemeroptera: Pannota). *Trans Amer Entomol Soc* 126: 337–371.

