

## KURENAI : Kyoto University Research Information Repository

Title	Reproductive Ecology of the Mayfly <i>Epeorus ikanonis</i> (Ephemeroptera:Heptageniidae)
Author(s)	Takemon, Yasuhiro
Citation	
Issue Date	1990-05-23
URL	<a href="http://hdl.handle.net/2433/86423">http://hdl.handle.net/2433/86423</a>
Rights	
Type	Thesis or Dissertation
Textversion	author

新制

理

708

京大附図

学位申請論文

竹門康弘

Reproductive Ecology of the Mayfly  
Epeorus ikanonis (Ephemeroptera: Heptageniidae)

ナミヒラタカゴウの繁殖生態

Yasuhiro TAKEMON.

竹内 康弘

Department of Zoology, Faculty of Science, Kyoto University

Functional Morphology of the Genitalia of Epeorus ikanonis  
(Ephemeroptera: Heptageniidae)

(Running title: Morphology of Genitalia in Epeorus ikanonis)

Yasuhiro TAKEMON

Department of Zoology, Faculty of Science, Kyoto University,  
Kyoto, 606 JAPAN

Functional Morphology of the Genitalia of Epeorus ikanonis  
(Ephemeroptera: Heptageniidae)\*

Yasuhiro TAKEMON

Department of Zoology, Faculty of Science, Kyoto University,  
Kyoto, 606 JAPAN

Abstract

Morphology of the genitalia and other reproductive organs was described for both sexes of the heptageniid mayfly Epeorus ikanonis Takahashi. Specimens fixed during copulation showed that the male genitalia changed in its shape when inserted in female genitalia. Morphological function of the male genitalia was examined in terms of sperm transfer into the seminal receptacle. And the sperm competition at successive copulation was discussed based on the location of the ejaculated sperm in female reproductive organs.

\* Contribution from the Laboratory of Animal Ecology,  
Kyoto University, No. XXX.

## Introduction

Harker (1986) pointed out a copulatory movement of penis in mayflies of the genus *Ecdyonurus*, and thereby he called attention to the taxonomic use of the morphology of genitalia. He showed that the dorsal side of each half of the penis lobes rotates inwards during copulation, though the function of this movement has never been explained. The morphological relations of genitalia between sexes should be examined using copulating pairs in order to clarify the function. However, it is generally difficult to obtain paired specimens of mayflies in copulation, since they are apt to separate at sampling.

The imagines of *Epeorus ikanonis* copulate on the ground spending more than five minutes (Takemon, unpublished), and thus it is rather easy to fix copulating pairs with their genitalia connecting each other. In this paper, the morphological function of the genitalia was investigated using these specimens. Females of this species show multiple copulation before oviposition (Takemon, unpublished). The sperm competition at successive copulation was discussed based on the location of sperm in the reproductive organs of females.

## Material and Methods

The heptageniid mayfly *Epeorus ikanonis* inhabits the upper to middle reaches of streams in Japanese low mountains (Kani, 1944), and has a univoltine life cycle, emerging in early spring (Gose, 1970). Specimens of the mayfly were collected at Yuyaga-dani-deai (altitude 350m) at the middle reaches of the Kibune Stream (35°0'N, 130°0'E), a tributary of the River Kamo running

through Kyoto City, in April 1987 and 1988. Copulating pairs on the stream shore were picked up with fingers and were immediately dipped into cases with absolute alcohol so as to avoid separation at fixation. I collected the pair specimens at various timing during copulation: i.e , 0'30", 1'00", 2'00", 3'00", and 5'00" after starting copulation, and just after copulation. I also sampled single males in the field and single females during or after oviposition. Virgin adults were obtained by rearing subimagines collected by sweeping during emergence flight or using emergence traps (Takemon, unpublished).

## Results

### Morphology of Female Genitalia

The external form of the female sternum was characterized by the subgenital plate covering more than half of the eighth sternum (Fig 1a,b). There was a distinctive space inside the subgenital plate called a vestibule by Brinck (1957)(Fig.1e). The oviducts opened separately into the vestibule from the sides of a chitinous plate (Fig.1d). There was a seminal receptacle and another flat pouch at the junction of the front wall of the oviducts (Fig.1e). The seminal receptacle opened with slit under the flat pouch (Fig 1f). The seminal receptacle was egg-shaped and was made of soft tissue, while the flat pouch was very thin and was made of rather hard tissue. The latter, thus, may well be called "a plate" covering the vestibule. Morphology of reproductive organs was not different among female specimens examined, except that females before oviposition had full of eggs in the oviducts which reached the end of the 8th abdominal segment, whereas those after

oviposition had only a few eggs in the posterior part of oviducts.

#### Morphology of Male Genitalia

Both virgin and single males had flat penis lobes outstretching postero-laterally (Fig.2a). The dorsal surface of penis lobes was made of thin chitinous membrane through which a posterior part of the ejaculatory duct was observed (Fig.3a), while their ventral side was rather strongly chitinous. A pair of spines was withdrawn in the depression at the base of penis lobes. The end of ejaculatory duct was closed at the brim of each penis lobe. A crevice opened longitudinally on the ventral side of the basal half of penis, which was closed with white soft tissue.

Virgin males had a pair of deflated testes and swollen seminal vesicles (Fig.4). Seminal vesicles connected with each other at the anterior part of the ejaculatory duct. This kind of connection has been known also in another mayfly *Hexagenia limbata occulta* according to Levy (1948). Specimens of swarming males showed various size of seminal vesicles irrespective with the body size represented by the fore wing length.

#### Change in Morphology of Male Genitalia during Copulation

Posture of abdomens during copulation is shown in Fig.2b. Male grasped female with a pair of forceps at the eighth abdominal segment and the penis was inserted into the vestibule with up side down. Dissection of the specimens revealed that the inserted penis reached in front of the seminal receptacle under the flat pouch.

The morphology of penis during copulation (copula-form: Fig.2c and 3b) was different distinctly from that of single specimens

(sole-form: Fig.2a and 3a) in the following respects : i.e., 1) the penis bent up to the dorsal direction at the base of penis lobes, 2) each half of the penis lobes rotated inwards and was doubled up longitudinally, 3) the end of each ejaculatory duct opened with a small slit at the brim of penis lobe on the folding line, 4) a pair of spines projected laterally as a result of the bending of penis and the rotation of penis lobes, and 5) the crevice on the ventral side widened and the ejaculatory duct could be seen through the thin white soft tissue.

#### Timing of Morphological Change during Copulation

Table 1 shows the percentage of copula-form and sole-form in the male specimens at each timing of copulation. Males with inserting penis always showed the copula-form after 0'30" from the start of copulation. The presence of two males having a sole-form penis at 0'30" suggests that the penis of sole-form can get into the vestibule, and therefore the morphological change of the penis occurred after insertion.

When pairs separated during fixation, some males returned their penis into the sole-form, and moreover, males after copulation had the sole-form with a high percentage. These facts show that the morphological change is reversible and the copula-form is apt to occur only during insertion.

The percentage of inserted specimens was high at 1'00 and 2'00" and was low at 0'30" and 5'00" Thus coherency of the pair was high in the first half of copulation and was low at the beginning and the second half of copulation.

### Sperm Transfer into Seminal Receptacle

Females during and just after copulation carried sperm in the seminal receptacle and some of them carried it also in the vestibule (Table 2) The flat pouch was vacant in all specimens. The sperm in the receptacle and in the vestibule was rather loose and was not bunched. Sperm in the vestibule was usually found under flat pouch but in exceptional three cases it was found also on the flat pouch. Although I did not measure the amount of carried sperm, it looked like varied among females, some of which clearly carried more sperm in the vestibule than in the seminal receptacle.

When did the ejaculation occur? Since females of this species showed multiple copulation (Takemon, unpublished), the sperm in the female genitalia was not always derived from the copulating male of the specimen. But following two facts suggest that the ejaculation occurs early in the copula duration. A female without sperm was found only at 0'30". On the other hand, a female carrying sperm in the vestibule was found at 1'00", though the female was after oviposition and spent all sperm in the seminal receptacle. The latter fact indicates that the sperm in the vestibule was derived from the pairing male.

Where was the sperm ejaculated? Considering the size of penis far bigger than the entrance of seminal receptacle, it seems to be impossible for males to ejaculate sperm directly into the seminal receptacle by inserting the penis lobes into it. Since there was a female carrying sperm only in the vestibule, males may ejaculate sperm in the vestibule. Then, why did almost all females carry sperm in the seminal receptacle in spite of only 40% - 80% of

females carrying it in the vestibule? The sperm may be transferred into the seminal receptacle by unknown process and surplus sperm may remain in the vestibule.

Females during and after oviposition had sperm only in the seminal receptacle or had no sperm. Considering many females carrying sperm in the vestibule after copulation, sperm in the vestibule may be used or washed away during oviposition.

#### Discussion

##### Function of Each Reproductive organ in *Epeorus ikanonis*

Thornhill & Alcock (1983) mentioned that females of mayflies lacked a spermatheca or other sperm storage organs and thus the sperm traveled directly to the eggs. They explained this was because mayflies are extremely short-lived in the adult stage and therefore derive no benefit from the ability to store sperm. However, Brinck (1957) presented the morphological variation of the female reproductive organs in mayflies, ranging from the non-modified simple gonopores (ex. Ephemeridae and Baetidae) to the strongly modified ones with the vestibule, a seminal receptacle, and copulatory pouches (ex. Heptageniidae, Siphonuridae and Ephemerellidae). Therefore the process of sperm reception and usage by females is expected to differ among species

The morphology of male genitalia is also diverged in mayflies such as a simple membranous projection in Baetidae, a pair of separated chitinous penis in Ephemeridae, and a united chitinous penis in Heptageniidae, Leptophlebiidae, and Ephemerellidae (Morgan, 1911; 1913; Morrison, 1919; Needham et al., 1935; Edmunds et al., 1976). The variation in the structure of male genitalia seems

to correspond to that of female reproductive organs, but further studies have never been done since Brinck (1957). In order to discuss in future on the morphological variation in mayfly genitalia, the functional morphology of each variation should be examined.

The female of *E. ikanonis* has modified oviducts with a seminal receptacle and a flat pouch. It is certain that the seminal receptacle functions to reserve the sperm until oviposition because all females after copulation had the sperm in this receptacle. Function of the flat pouch is uncertain. Brinck (1957) confirmed the penetration of the penis into the copulatory pouch by examining mating pairs of *Parameletus chelifer*. Palmen (1884) also demonstrated the same function of the pouch in *Ecdyonurus*. Although the flat pouch of *E.ikanonis* seems to be homological to the copulatory pouch described in Brinck (1957) and Palmen (1884), neither penetration of penis nor ejaculation of sperm in the pouch was observed in this species.

The male genitalia of this species is characterized by its reversible change from sole-form to copula-form. Morphological change of male genitalia at copulation has been also known in other mayflies such as *Baetis* of which male projects a membranous penis (Edmunds et al., 1976), and *Ecdyonurus* of which male shows the movement of penis-lobes by rotation (Harker, 1986) The latter case seems to have the similar function to that of *E.ikanonis*.

Why do males of this species bend their penis and rotate its lobes in the copula-form? Males seem to ejaculate sperm by the penis of copula-form. Outlets of ejaculatory ducts come together on the centre line and open toward dorsal direction as a result of

the bending and the rotation. This posture will lead sperm to go downward at the centre of the vestibule at ejaculation, since the penis is inserted with up side down. Considering that the seminal receptacle is located middle at the front wall of oviducts and its entrance is under the flat pouch, the copula-form seems to be advantageous to transfer sperm into the seminal receptacle.

The penis of copula-form is also characterized by spines projecting laterally. How do the spines function? Coherency of a copulating pair was high in the first half of copulation, during which the ejaculation seems to occur. The projection of spines in the copula-form may be of use for fixing genitalia of each other during copulation.

#### Sperm Competition in *Epeorus ikanonis*

The eggs of mayflies with non-modified simple gonopores are presumably fertilized by the sperm traveling into the oviducts. In contrast, the species with a seminal receptacle have various possibilities in terms of sperm precedence. Since females of this species conduct multiple copulation (Takemon, unpublished), the sperm precedence at successive copulation becomes of importance for considering the mating system. In this section, the mechanism of sperm utilization is inferred from the morphology of genitalia and the location of the ejaculated sperm in the female genitalia during and after copulation.

The penis of some odonates is modified so as to pull out the previous sperm (in case of Zygoptera) or to push out it (in case of Anisoptera) aiming at the displacement of sperm in the spermatheca (e.g., Waage, 1984). The penis structure of this species

is unfit for such a kinematical sperm displacement. Absence of the sperm depletion in the seminal receptacle during copulation also suggests that males does not pull out the previous sperm in this species. Males of some dipteran species use a mating plug to prevent the sperm of successive mating from entering a spermatheca (Nielsen,1959; Parker,1970). The male of this species, however, lacks accessory glands for producing enough substance for a mating plug. Males of some lepidopteran species deposit a spermatophore at the outlet of a copulatory pouch and thus the sperm of the last copulation is transferred first into a spermatheca and is used for fertilization (Drummond III,1984) As the sperm of this species is held in a loose manner in the seminal receptacle and the vestibule, the "last-in first-out" mechanism seems to be improbable at least in a strict manner.

Though sperm was found in the vestibule in some females during and after copulation, females during and after oviposition did not carry it in the vestibule. Considering that some females had more sperm in the vestibule than in the seminal receptacle, the sperm in the vestibule must have been washed away during oviposition even if a part of it had been used for fertilization. In contrast, 75% of females retained sperm in the seminal receptacle. If the sperm in the vestibule had been pushed out with eggs early during oviposition, its fertilizing success may be lower than that of the sperm in the seminal receptacle. And vice versa if the sperm in the vestibule had been used through out oviposition. The former possibility seems more probable because the copula-form of male genitalia is aiming at ejaculation into the seminal receptacle. In case of the latter possibility, males do not have to ejaculate

aming at the seminal receptacle.

At last the sperm of successive copulation is expected to have some chance of fertilization, because the sperm of successive copulation seems to remain in the vestibule and it can fertilize eggs at least at the beginning of oviposition. The measurement of P2 ratio is wanted for the verification of this estimation.

#### Acknowledgements

I wish to thank Prof. Hiroya Kawanabe, Dept. Zoology, Kyoto University, for supervision through the study, Dr. Takuya Abe, Dept. Zoology, Kyoto University, and Dr. Takayoshi Nishida, Dept. Agriculture, Kyoto University, for their critical reading of the draft of this paper, Mr. Kosaburo Torii for kindly allowing use of his property for the field work, Miss Midori Kaihatsu, Dept. Biology, Nara Women's University, for help with sampling, Mr. Norio Kobayashi for kindly allowing inquiry of his library, and other members of the Laboratory of Animal Ecology in Kyoto University for their useful comments. This study is partially supported by the Grand-in-Aid of Scientific Research (No. 61480005), for Cooperative Research (No. 62304003) and for Special Project Research on Biological Aspect of Optimal Strategy and Social Structure (Nos. 59115504 and 6107092) from Japan Ministry of Education, Science and Culture.

## REFERENCES

- Brinck, P., 1957. Reproductive system and mating in Ephemeroptera. Opusc. Ent., 22:1-37
- Drummond III, B. A., 1984. Multiple mating and sperm competition in the Lepidoptera. In Smith, R. L., (ed.) Sperm competition and the evolution of animal mating systems. pp. 291-370. Academic Press, Orland.
- Edmunds, G. F., S. L. Jensen & L. Berner, 1976. The Mayflies of North and Central America. 330 pp. Univ. Minn. Press, Minneapolis.
- Gose, K., 1970. Life histories of some species of Ephemeroptera and Plecoptera at Ikadaba in the Yoshino River. In Productivity of the Yoshino River, 2: 8-13. (In Japanese)
- Harker, J. E., 1986. The effect of the environment and copulatory movements on the taxonomic characters of three species of Ecdyonurus (Ephemeroptera) Journal of Natural History, 20: 635-647.
- Kani, T., 1944. Ecology of torrent-inhabiting insects. In Furukawa, H., (ed.) Insects. I. pp. 171-317. Kenkyu-sha, Tokyo. Also in Kani's Complete Works., 1978. pp.3-91. Shisaku-sha, Tokyo. (In Japanese).
- Levy, H. A., 1948. The male genitalia of Ephemeroptera (mayflies). J. N. Y. Ent. Soc., 56: 25-37, 4 pls.
- Morgan, A. H. 1911. Mayflies of Fall Creek. Ann. Ent. Soc. Amer., 4: 93-119, 7 pls.
- 1913. A contribution to the biology of mayflies. Ann. Entomol. Soc. America, 6: 371-413, 13 pls.

- Morrison, E. R. 1919 The mayfly ovipositor, with notes on Leptophlebia and Hagenulus. Can. Ent., 51: 139-146
- Needham, J. G., J. R. Traver & Yin-Chi Hsu, 1935. The Biology of Mayflies. 759 pp., 14 pls. Comstock Publ.Co., New York.
- Nielsen, E. T., 1959. Copulation of Glyptotendipes (Phytotendipes) paripes Edwards. Nature, 184: 1252-53.
- Palmen, J. A , 1884. Uber paarige Ausfuhrungsgange der Geschlechtsorgane bei Insecten. 108 pp., 5pls. Diss. Helsingfords. (Referred after Brinck, 1957)
- Parker, G. A., 1970. Sperm competition and its evolutionary consequences in the insects. Biol. Rev. 45: 525-567.
- Takemon, Y , 1985. Emerging behaviour of Ephemera strigata and E.japonica (Ephemeroptera: Ephemeridae). Physiol. Ecol. Japan, 22: 17-36.
- Tanida, K., 1980. Life history and distribution of three species of Hydropsyche (Trichoptera: Hydropsychidae) in the River Kibune (Kyoto, Central Japan), with particular reference to the variations in their life cycle and the relation of larval growth to their density. Jap. J. Limnol., 41: 95-111.
- Thornhill, R. & J. Alcock, 1983 The evolution of insect mating systems. 547 pp. Harvard Univ. Press, Cambridge.
- Waage, J. K., 1984. Sperm competition and the evolution of Odonate mating systems. In Smith, R. L., (ed.) Sperm competition and evolution of animal mating systems. pp. 251-290. Academic Press, Orland.

Table 1. Timing of morphological change in the penis during copulation in Epeorus  
ikanonis. Numerals represent the number of males and those in parentheses percentage.

	0'30	after start of copulation				just after copulation
		1'00"	2'00"	3'00"	5'00"	
inserted*						
sole-form	2 (50.0)	0	0	0	0	-
copula-form	2 (50.0)	4 (100)	3 (100)	3 (100)	1 (100)	-
total***	4 (44.4)	4 (57.1)	3 (60.0)	3 (50.0)	1 (20.0)	-
separated**						
sole-form	3 (60.0)	1 (33.3)	0	2 (66.7)	2 (50.0)	5 (83.3)
copula-form	2 (40.0)	2 (66.7)	2 (100)	1 (33.3)	2 (50.0)	1 (16.7)
total***	5 (55.6)	3 (42.9)	2 (40.0)	3 (50.0)	4 (80.0)	6 (100)
total examined	9 (100)	7 (100)	5 (100)	6 (100)	5 (100)	6 (100)****

\* Specimens of pairs being connected each other with genitalia.

\*\* Specimens of pairs being separated each other during fixation.

\*\*\* Numbers in parentheses show the percentage of inserted- or separated-pairs  
in the specimens.

\*\*\*\* Copula duration of these pairs were 4'15" 4'48" 6'25" 7'10" 9'21" and 9'29"

Table 2. Location of sperm in the reproductive organs of females during copulation in Epeorus ikanonis. Examined pairs are the same ones as in Table 1. Numerals represent the number of females and those in parentheses percentage. S.R. = seminal receptacle; V. = vestibule.

	0'30"	after start of copulation				just after copulation	during or after oviposition
		1'00"	2'00"	3'00"	5'00"		
Pre-oviposition*							
stored in							
S.R.	7 (87.5)	6 (100)	5 (100)	6 (100)	5 (100)	6 (100)	-
V	5 (62.5)	4 (66.7)	4 (80.0)	3 (50.0)	2 (40.0)	3 (50.0)	-
vacant	1 (12.5)	0	0	0	0	0	-
Post-oviposition**							
stored in							
S.R.	0	0	0	0	0	0	6 (75.0)
V.	0	1 (100)	0	0	0	0	0
vacant	1 (100)	0	0	0	0	0	2 (25.0)
total examined	9	7	5	6	5	6	8

\* Female had full of eggs in the oviducts.

\*\* Female had only a small number of eggs in the oviducts.

## LEGENDS

Fig.1. Morphology of the female reproductive system in *Epeorus ikanonis*. The illustrated specimen was a female after oviposition preserved in alcohol. (a) Ventral view of the female abdomen. (b) Lateral view. (c) Dorsal view after the dorsal tergite was removed. (d) Dorsal view after tracheae, muscle and nerve system were removed. (e) Dorsal view after the eighth sternum and the remaining eggs were removed. (f) Ventral view of the seminal receptacle and the flat pouch. Abbreviations: ct= chitin, fl= flat pouch, ms= muscle, nv= nerve, out= outlet of oviduct, ovd= oviduct, sgp= subgenital plate, sl= slit, sr= seminal receptacle, st8= eighth sternum.

Fig.2. External morphology of the male reproductive organs in *Epeorus ikanonis*. (a) Dorsal view of the terminal abdomen of a solitary male. (b) Posture of abdomens of a pair during copulation. (c) Dorsal view of the terminal abdomen of a copulating male. Each figure was drawn from specimens in alcohol.

Fig.3. Morphological comparison of penis between the sole-form (a) and the copula-form (b). 1: ventral view, 2: lateral view, 3: postero-dorsal view, and 4: dorsal view.

Fig.4. Morphology of the male reproductive system of a virgin male in the ventral view (left figure) and the various stages of the sperm amount reserved in wild-caught males. The numerical value of fwl means the fore wing length in mm of each specimen. The fore wing length of the virgin male was 11.87 mm. Abbreviations: ej= ejaculatory duct, sv=seminal vesicle, t=testis.

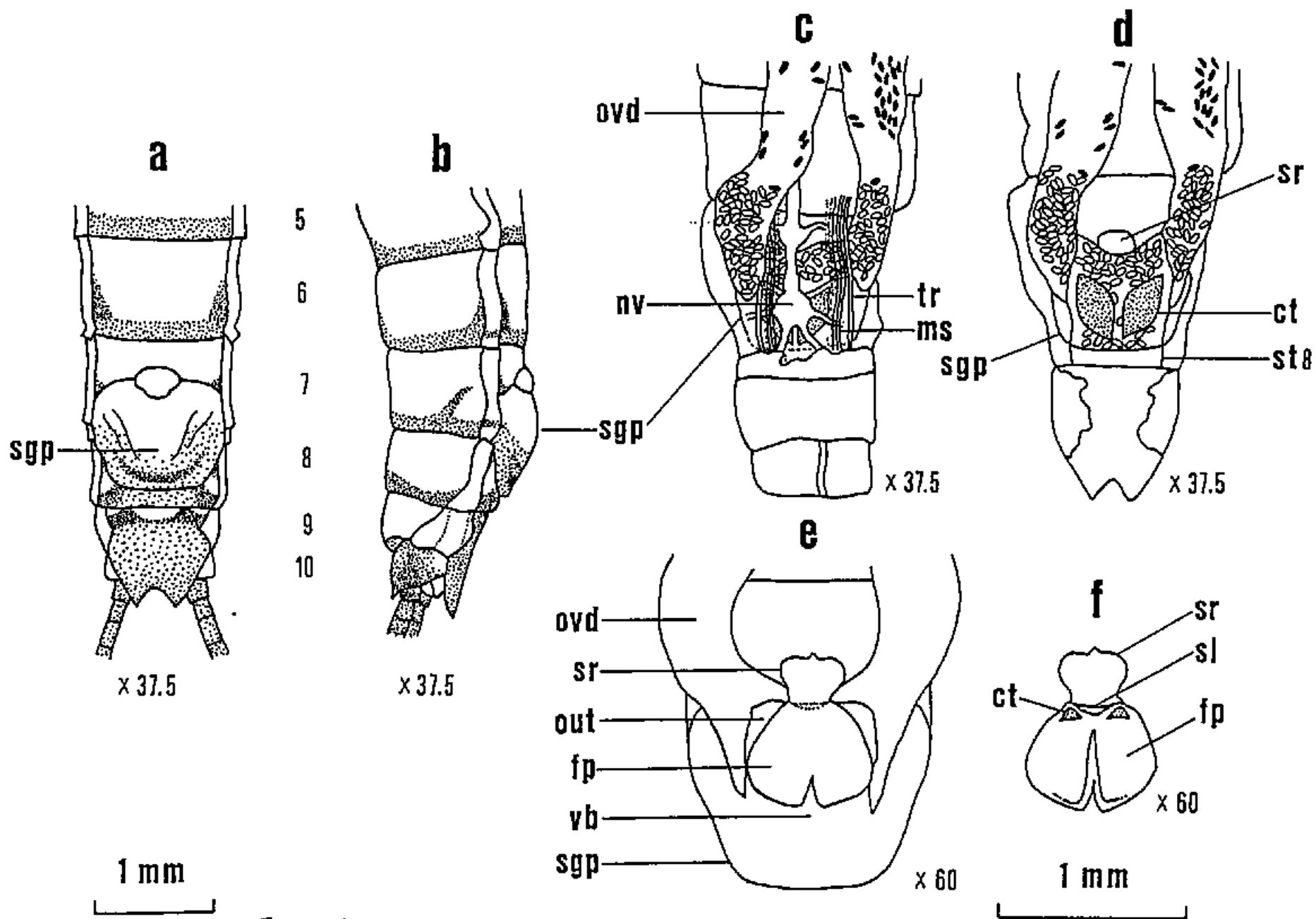
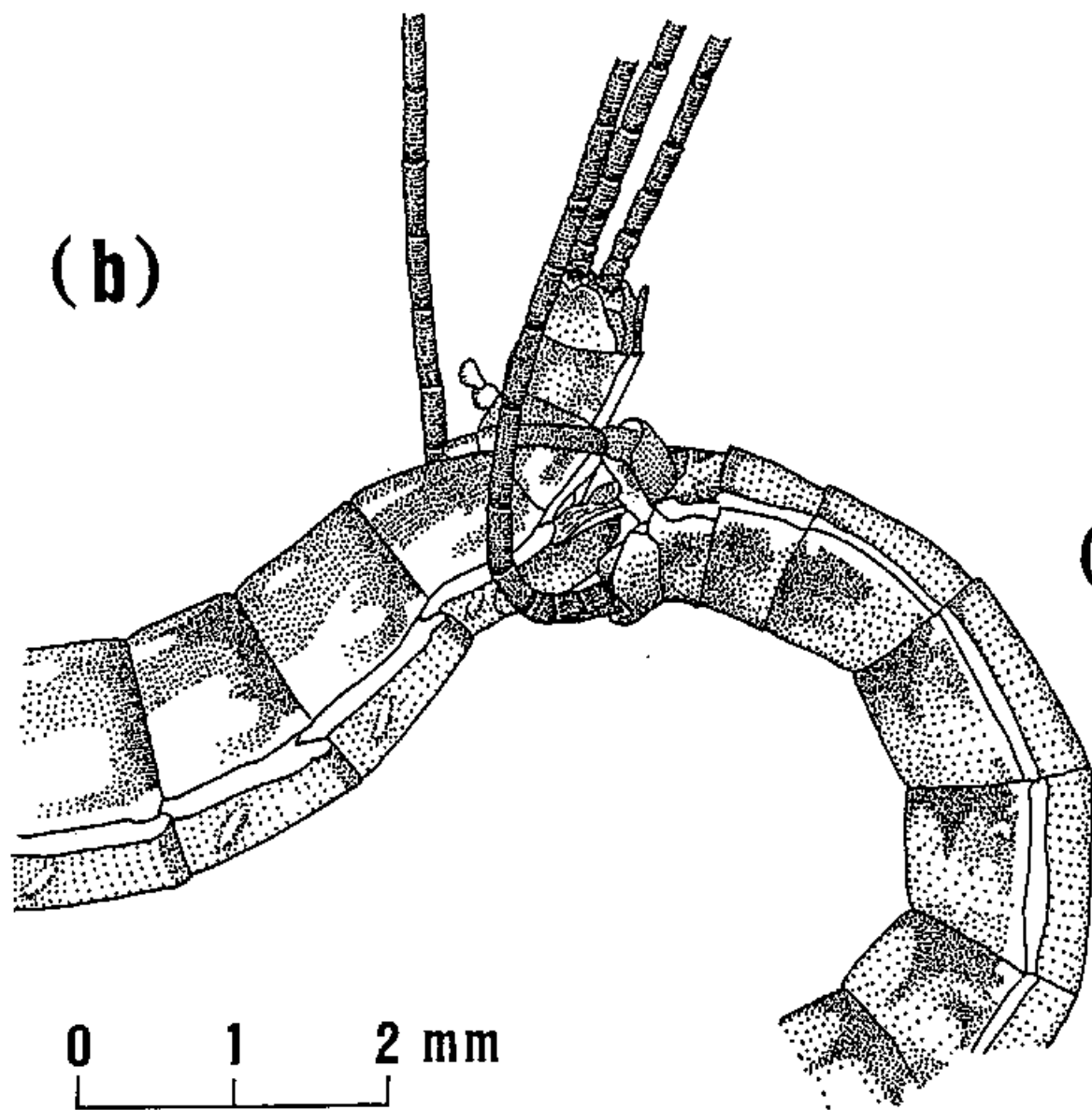
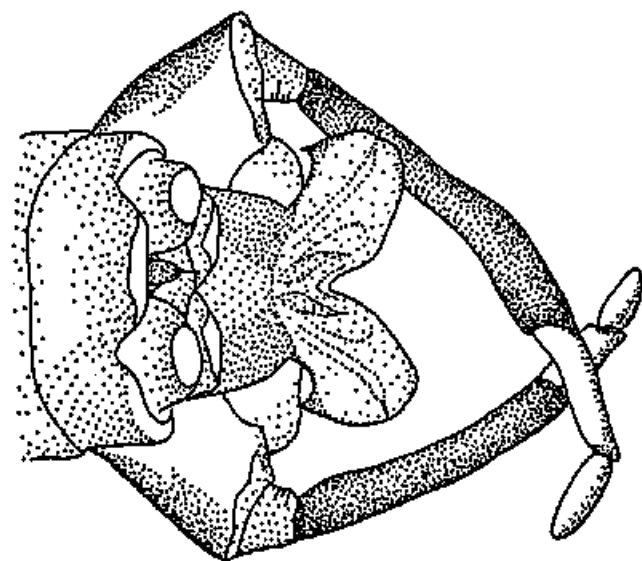

Fig 1.

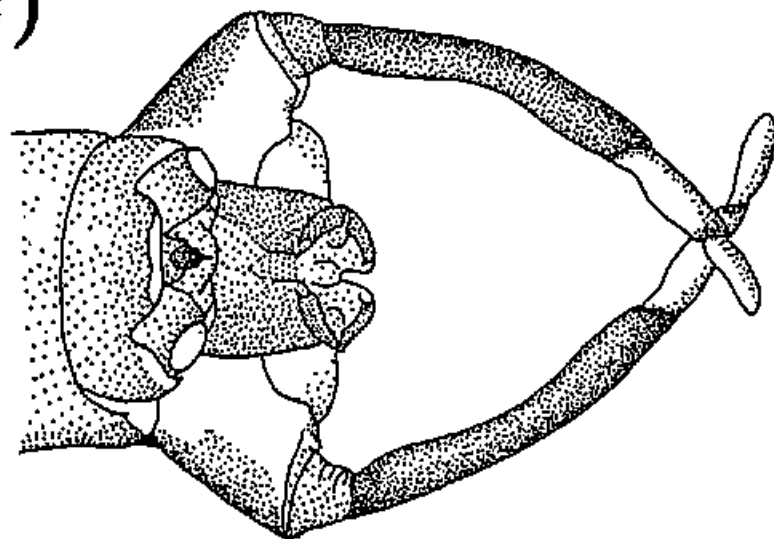

*Fig. 2.*

**(a)**



**(c)**



0 1 mm

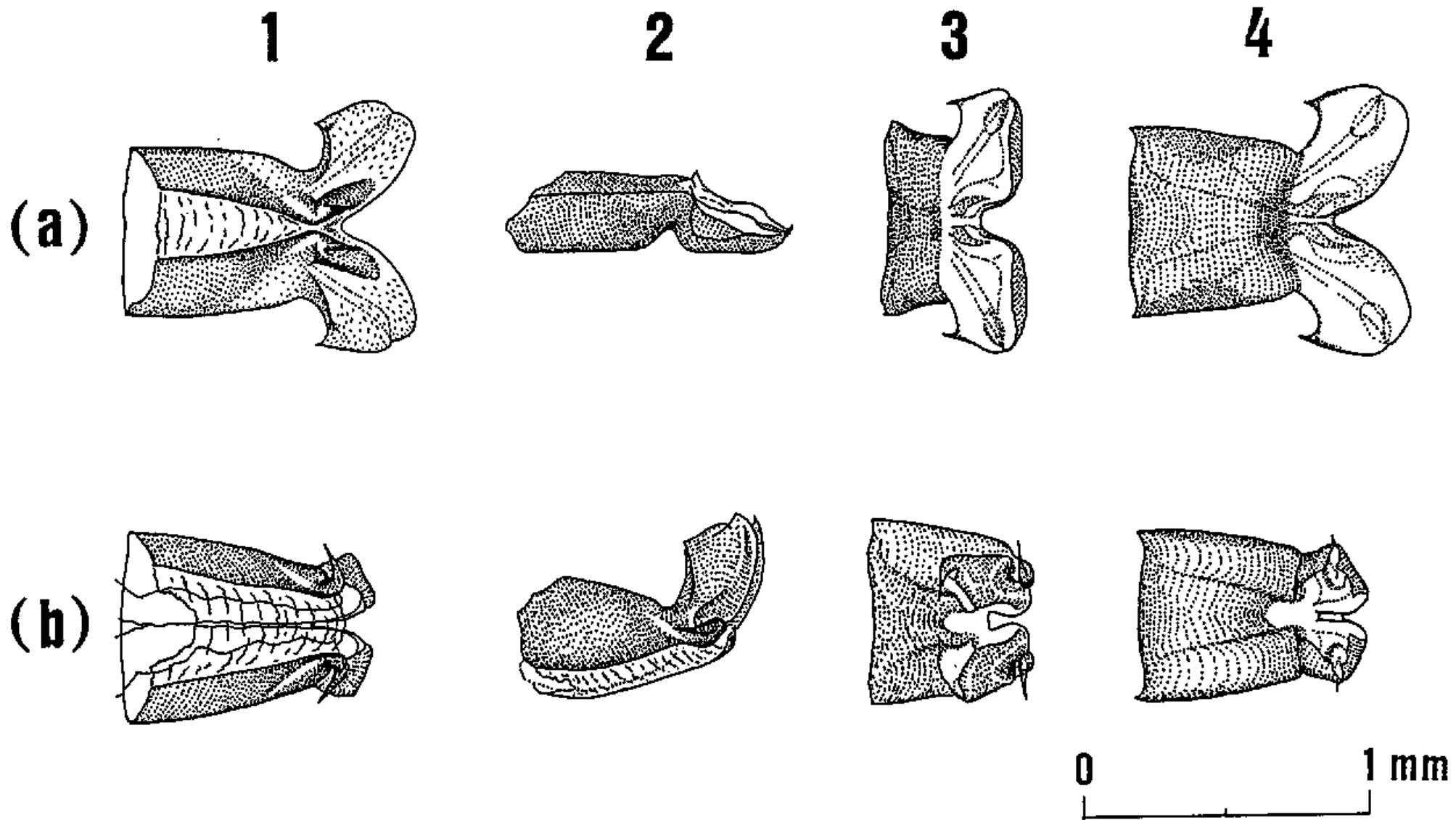

*Fig. 3.*

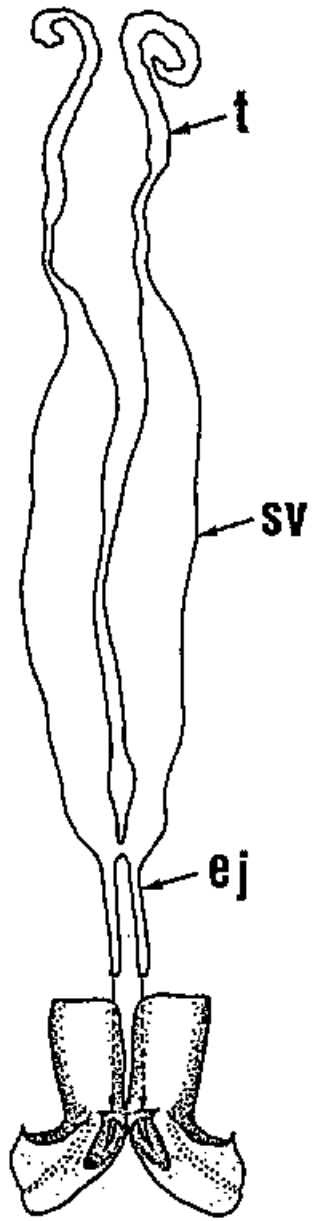

**fwl= 12.95**

**11.69**

**13.92**

**12.80**

**12.29**

**12.05**

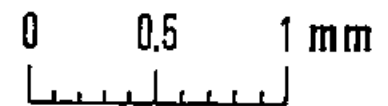

Water Intake by Adult Male Mayflies  
and Its Effect on Their Longevity\*

Yasuhiro TAKEMON

Department of Zoology, Faculty of Science,  
Kyoto University, Kyoto, 606 JAPAN

\* Contribution from the Laboratory of Animal Ecology,  
Kyoto University, No. XXX

## ABSTRACT

Field observations were made on water drinking behaviour of adult males of *Epeorus ikanonis* Takahashi, *Epeorus napaeus* Imanishi, *Ecdyonurus tobiironis* Takahashi, and *Ephemera strigata* Eaton during their reproduction. The amount of water intake was estimated and its effect on the adult longevity of *E.ikanonis* was investigated by rearing under natural conditions. Males without water supply died in six days, whereas those supplied with water lived for up to sixteen days. Thus, field males of the above four species are believed to increase their longevity by drinking water.

## INTRODUCTION

During observation on the male swarming behaviour of the mayfly *Epeorus ikanonis* at the bankside of Kibune Stream in 1986, one of the swarming males alighted on the water surface and then settled on the bankside vegetation carrying a water drop underside of the head capsule. This droplet was gradually imbibed by the mayfly, and this is the first record of water intake by adult mayflies. However, the author previously observed the alighting of swarming males on the water surface in several other species of mayflies, and the phenomenon of water intake in adult males may be rather common among mayflies.

Since the mouthparts of adult mayflies are vestigial (Needham et al., 1935; Burks, 1953), they have been believed to be non-functional (Edmunds et al., 1976). However, although feeding by adult mayflies is not possible, the possibility of water intake using the vestigial mouthparts remains. It has also been believed that adult mayflies have a very short lifespan, since they do not feed, and consequently, the lifespan of mayflies has been estimated by rearing experiments without water supply (Allan & Flecker, 1989). However, considering the water drinking of mayflies in the field, laboratory data on adult lifespan may be serious underestimation.

The present study describes the water drinking behaviour and head capsule morphology, and estimates the amount of water intake for the four species, *Epeorus ikanonis*, *Epeorus napaeus*, *Ecdyonurus tobiironis*, and *Ephemera strigata*. The adult longevity is then compared between water supplied and non-supplied individuals of *Epeorus ikanonis* and the relation between longevity

and reproduction is discussed.

## MATERIAL AND METHODS

### Study Sites and Field Observation

Water drinking behaviour of adult males of *E.ikanonis*, *E.napaeus*, and *E.tobiironis* was observed at Okunomiya (elevation 340m) and Yuyaga-dani-deai (elevation 350m) at the middle reaches of Kibune Stream (width 2-5m), a branch of the River Kamo in Kyoto City (35° 0'N, 130° 0'E). The observation was conducted for *E.ikanonis* on 15, 16 April 1987, and 16, 27 April 1988, for *E.napaeus* on 26 April 1988, and *E.tobiironis* on 20 and 28 April 1988. That of *E.strigata* was observed at Ichihara (elevation 150m) at the lower reaches of Kurama Stream (width 5-13m) in May 1984 and 1987.

Observations of males swarming above the stream or sitting on the ground were made for each species. Males showing the alighting behaviour on the water surface were traced until perching on riparian vegetation and the drinking behaviour was observed closely, recording the site, method of water drinking, and the time required for intake of water. For *E.strigata*, one of several swarming sites above the stream was selected, and the number of individuals alighting on the water surface, the number of swarming males and passing females, and the number of copulations occurring in the swarm were counted at one minute intervals from 15:30 to 19:00 on 19 May 1984.

In order to estimate the amount of water intake, field adults of *E.ikanonis*, *E.napaeus* and *E.tobiironis* were captured and a small droplet of water placed on the mouthparts using a pair of sharply

pointed tweezers. Droplet volume was later measured to the nearest of 0.1 ul in the laboratory using a micro pipette. Results showed an average droplet volume of 2.2 ul (range=0.8-3.7, SD=0.55, N=630).

Adults of the four species were collected in the field and were preserved in 75% alcohol after measuring the fresh body weight. These individuals were also used for morphological observations of the head capsule and mouthparts.

#### Estimation of Longevity

Longevity in the adult stage of *E.ikanonis* was estimated by rearing adults from subimagines to death under the natural conditions at Okunomiya from 29 March to 28 April 1988. Subimagines were captured by net when they emerged from the water surface on 6 days in late March / early April, and were stored in field cages of size 30 x 30 x 40 cm in the shade of a house wall beside the stream. Since the date of moulting into imagines differed among individuals within a cage, all adults were individually marked with lacquer dots on the day of emergence. Adults which failed to moult successfully were excluded from results, since such individuals always died far earlier than normal individuals. Each set of adults was separated into two groups, one of which received no water, whereas the other was supplied with a water droplet (average volume 2.2 ul) every day. The method of water supply was as described for measuring the amount of water intake. Fig. 1 shows the diel and seasonal change of air temperature and humidity recorded by a thermo-hygrograph set in the same place as the cages at the study site.

## RESULTS AND DISCUSSION

### Water Drinking Behaviour

#### *E. ikanonis*

Seven males of this species were observed to alight on the surface of water, five of which had hovered above the stream at a height of 1.0-3.5m, descended gradually, and alighted on the surface of water, whereas the rest two males had been sitting on the shore before alighting on the stream. The alighting sites were distributed around the middle of a rapid or the slow current parts of the stream. Four of the seven males were successfully traced to their perching sites on the bankside vegetation. Each male had a small droplet of water on the underside of the head capsule, which formed a somewhat swollen hemisphere. The time required for intake of all the water was 48, 105, 112 and 119 seconds from the alighting on the surface of water. After drinking water males remained at the perching site or flew up to tree canopies and did not return to the swarming sites or the stream shore. The diel timing of water drinking behaviour was in the afternoon between 12:20 and 17:00, and although adult males were present from around 10:00 a.m., no water drinking was observed during the morning.

#### *E. napaeus*

Two males, which had engaged in the up-and-down flight above stream at the height of 0.6-2.0m, were observed to drink water. Each male alighted on the water surface at 15:11 and 15:16, and took off immediately to perch on bankside vegetation with a water hemisphere on the underside of the head capsule. This droplet took 104 and 115 seconds to drink, respectively. These males later flew

back to the swarming site and resumed the up-and-down flight. On the day of observation, males of this species began the up-and-down flight at 14:45, increased in number towards a peak at 15:57, and disappeared at 17:10. Thus, the water drinking behaviour occurred in the midst of their reproduction.

*E.tobiironis*

Four males of this species were observed to drink water. Two of them had hovered above a slow current part of the stream at heights of 0.3m and 1.0m, before alighting on the water surface at 14:50 on 20 April and, 14:58 on 28 April, respectively. The other two males were sitting on the stream shore before alighted near the stream center at 14:05 on 20 April and 14:46 on 28 April, respectively. The latter male took off to drink water immediately after copulating on the ground. After taking off from the water surface, all males perched on the leaves of bankside bushes and each had droplets of water on the underside of the head capsule. These droplets were drunk in 93, 123, 125, and 134 seconds, respectively. Shortly after they flew back to the stream but were not able to be traced further. The reproduction of this species started before 11:10, reached the peak in the number of males sitting on the stream shore between 12:33 and 13:49, and ended before 16:20 on 28 April 1988. Thus, the timing of water drinking was during reproduction.

*E.strigata*

Five males of this species were observed drinking water in the afternoon on 9 and 10 May 1987. They appeared from the tree

canopies at a height of 6-20m, flew down directly to the stream, briefly alighted on the water surface and then flew up quickly to perch on bankside trees and bushes. These males also carried a swollen hemisphere of water on the underside of the head capsule, and took approximately 1 minute to drink it.

A diel change in adult activity was observed on 19 May 1984, when the alighting behaviour on the water surface preceded reproductive behaviour such as male swarming, female flight along the stream, copulation in the air, etc.(Fig.2). Since most of the alighting adults appeared from the tree canopies high above the stream (ca. 20m) and flew back there, it was not confirmed whether they carried a droplet of water under the head capsule or not. However, their behaviour was almost identical to that described as water drinking behaviour in 1987.

#### Morphology of Head Capsule and Mouthparts

Fig. 3 shows the morphology of head capsule and mouthparts of adult males of the four species. The mouthparts were highly degenerate, and both mandible and maxilla were immovable in all species. Located either side of the small tip of the labrum, were concave halls through which the water seemed to be taken in. How are males of these four species able to catch water during the brief contact with the water surface? The head capsule morphology may play an important role in this respect. The frontal margin of the head capsule is concave, and the edge was thus of use in enabling a water droplet adhere to the mouthparts by surface tension. The fringe of the head capsule extended further forward in *E.ikanonis* and *E.tobiironis* and than in *E.napaeus* and

*E.strigata*. This difference of this feature may relate with the volume of water taken in at a time.

#### Amount of Water Intake

Since the water was carried in the form of a swollen hemisphere, the volume of a water droplet was calculated assuming the mean value of width and length of underside of the head capsule to be the diameter of the hemisphere (Table 1). Males of *E.strigata* have a relatively small head capsule and less extended frontal margin, and thus, the weight of water taken per body weight was estimated to be the lowest among the four species. Conversely, the amount of water taken by the three heptageniid mayflies was estimated to exceed 2% of their body weight. It should be also noted that these values are likely underestimations, since the water droplets carried by field males were more swollen than an exact hemisphere.

The average volume of water supplied experimentally was 2.2ul, which was far larger than the volume of hemispheres estimated in Table 1. Thus, the water droplet adhered to the underside of the head capsule looked like a sphere rather than a hemisphere. In spite of the relatively large volume supplied, it was completely imbibed by 2 of 10 males of *E.ikanonis*, one of 10 males of *E.napseus*, and 2 of 10 males of *E.tobiironis*. However a second drop of water supplied to the males remained in the shape of a sphere, and the supplied water volume of 2.2ul thus seems near the maximum volume capable of being drunk at one time. The fact that some individuals completely drank the water droplet shows that the males of these three species have the ability to drink water over

10% of their body weight.

#### Relations of Water Intake to Evaporation

Although mayflies lose about 22% of the body weight when they cast the skin of subimago, that lost through evaporation consists of more than 20% since the weight of the skin itself is only about 1.5% of the body weight (Lameere, 1917). Adults may thus need to recover the water evaporated at and after moulting by drinking water.

Since evaporation from the body is influenced by atmospheric humidity, the water requirements should increase when the adult is exposed to the dry air. The present study clearly showed that the diel timing of the water drinking of each species to be in the afternoon, despite differences in the period of reproduction, and this may well reflect the decrease of humidity during daytime (Fig.1).

#### Effect of Water Intake on the Adult Lifespan of *Epeorus ikanonis*

Fig. 4 shows the difference of survival curves between water supplied and non-supplied individuals. Males and females in the former group survived for up to 16 and 10 days, but those in the latter group for only 6 and 7 days, respectively. The difference was more conspicuous among males. The average longevity also differed significantly in each sex (Table 2). The body of individuals not supplied with water were wrinkled, because of evaporation, at death, whereas those supplied with water were being soft, even just after death. Thus, the 2.2ul of water supplied daily in this experiment is probably sufficient for their

demands.

#### Relation between Lifespan and Reproduction in *Epeorus ikanonis*

The short longevity of females compared to males in *E.ikanonis* may be related to the method of oviposition: i.e., since this species lays all eggs at one time (Takemon, unpublished), the selection for survival after oviposition should not be intensive. Most of the females had expelled the eggmass when they died, in spite of the dry circumstance inside the cage. When conditions for reproduction, such as the weather, the air temperature, and the diel timing are suitable, the females may be unable to postpone oviposition. Copulation in the cage was also observed several times. Since this species copulates on the ground (Takemon, unpublished), the mating could be performed within the confines of the cage. Females which died after expelling the eggmass might have shortened lifespans due to copulation and oviposition. To investigate whether the females are able to live waiting for reproduction, it is necessary to rear them apart from males and restrain their oviposition.

Meanwhile, males of this species exhibited multiple copulation inside the cages and it is highly probable that they also copulate multiply in the field. In such a situation, it is advantageous for males to have an increased lifespan since their opportunity of mating will also increase. Consequently, the water drinking behaviour of male mayflies may be a strategy of increasing longevity and lifetime reproductive success.

#### ACKNOWLEDGMENTS

I wish to thank Drs. T.Abe, A.Rossiter, and M.Kohda, Messers. J.Yamamoto, N.Ohnishi, Y.Wada, Nishikawa, N.Shimizu, S.Kamata, S Takeichi, S.Shimazaki, T.Matsuo, H.Takahashi, and Mss. N.Okayasu, M.Ichikawa, K.Nishio, N.Tsutsui, A.Koyama, Y.Nakamoto, and M.Kaihatsu for help with field work, Mr. K.Torii for allowing use of his property for the field work, Mr. A.Taki for his helpful advice on the laboratory work, and Prof. H.Kawanabe, Drs. A.Rossiter, T.Abe, K.Tanida, and T.Nishida for their helpful criticisms on the draft of this paper. This study was partially supported by the Grand-in-Aid of Scientific Research (No. 61480005), for Cooperative Research (No.62304003) and for Special Project Research on Biological Aspects of Optimal Strategy and Social Structure (Nos. 59115504 and 6107092) from Japan Ministry of Education, Science and Culture.

#### REFERENCES

- Allan, J.D. & Flecker, A.S. 1989. The mating biology of a mass-swarming mayfly. *Anim. Behav.* 37:361-371.
- Burks, B.D. 1953. The Mayflies, or Ephemeroptera, of Illinois. *Ill. Natur. Hist. Surv. Bull.* 26(1). 216pp.
- Edmunds, G.F., Jensen, S.L. & Berner, L. 1976. The Mayflies of North and Central America. 330pp. Univ. Minn. Press. Minneapolis.
- Lameere, A. 1917. Etude sur l'evolution des ephemeres. *Bule. Soc. Zool. France* 42:41-59, 61-81.
- Needham, J.G., Traver, J.R. & Hsu, Yin-Chi. 1935. The Biology of Mayflies. xiv+759pp. Comstock Publ. Co., N.Y.

Table 1. Fresh weight of the adult males of four species of mayfly and the estimated amount of water taken in based on an assumption that the diameter of the water hemisphere is the mean value of the width and length of the head capsule. The part measured for the width and length is shown in Fig. 2.

Species	Fresh weight			Size of Head capsule		Volume of hemisphere ( $\mu$ l)	Mg % taken in
	Mean (mg)	SD (mg)	N	Width (mm)	Length (mm)		
<u>Epeorus ikanonis</u>	14.6	2.5	24	1.61	0.82	0.48	3.3
<u>Epeorus papaeus</u>	16.9	3.3	24	1.68	0.80	0.39	2.3
<u>Ecdyonurus tobiironis</u>	15.6	2.8	23	1.73	0.99	0.66	4.2
<u>Ephemera strigata</u>	27.2	5.4	21	1.43	0.91	0.42	1.5

Table 2. Average adult longevity of Epeorus ikanonis.

	mean (days)	SE (days)	N
Water supplied			
Male	7.8*	0.522	41
Female	5.7**	0.498	18
unsupplied			
Male	3.3***	0.205	29
Female	4.0****	0.553	9

Means differed significantly (\*-\*\*:  $0.05 < P < 0.01$ , t-test, \*-\*\*\*:  $P < 0.01$ , Cochran-Cox Method, \*-\*\*\*\*:  $P < 0.01$ , t-test, \*\*-\*\*\*:  $P < 0.01$ , Cochran-Cox Method, \*\*-\*\*\*\*:  $0.05 < P < 0.01$ , t-test) but not \*\*\*-\*\*\*\*:  $P > 0.05$ , t-test.

## LEGENDS

Figure 1. Diel and seasonal change of air temperature (upper) and humidity (lower) at Okunomiya during the rearing experiment of *Epeorus ikanonis* from 29 March to 28 April 1988. Upper symbols represent the weather conditions: open circle-clear fine, circle with a vertical bar-fine, double circles-cloudy, and a closed circle-rainy.

Figure 2. Diel timing of water drinking behaviour and reproductive behaviour in *Ephemera strigata* at Ichihara on 19 May 1984. An arrow represents the alighting of an individual the water surface, closed circles-the number of swarming males, the upper bar-the number of females passing the observation site along the stream each minute, the lower bar-the number of copula occurring in the male swarm each minute.

Figure 3. Head capsule morphology of *Epeorus ikanonis* (a), *Epeorus napaeus* (b), *Ecdyonurus tobiironis* (c), and *Ephemera strigata* (d). Top, middle and bottom figures illustrate front, dorsal, and ventral views, respectively. Each horizontal and vertical bar represents the width and length of the ventral side of head capsule, respectively, as used to estimate the volume of water hemisphere. All drawn to same scale.

Figure 4. Adult lifespan of the mayfly *Epeorus ikanonis* based on 98 individuals captured in the subimaginal stage and reared in field cages. Day 1 is the day of moulting into the imaginal stage from the subimago.

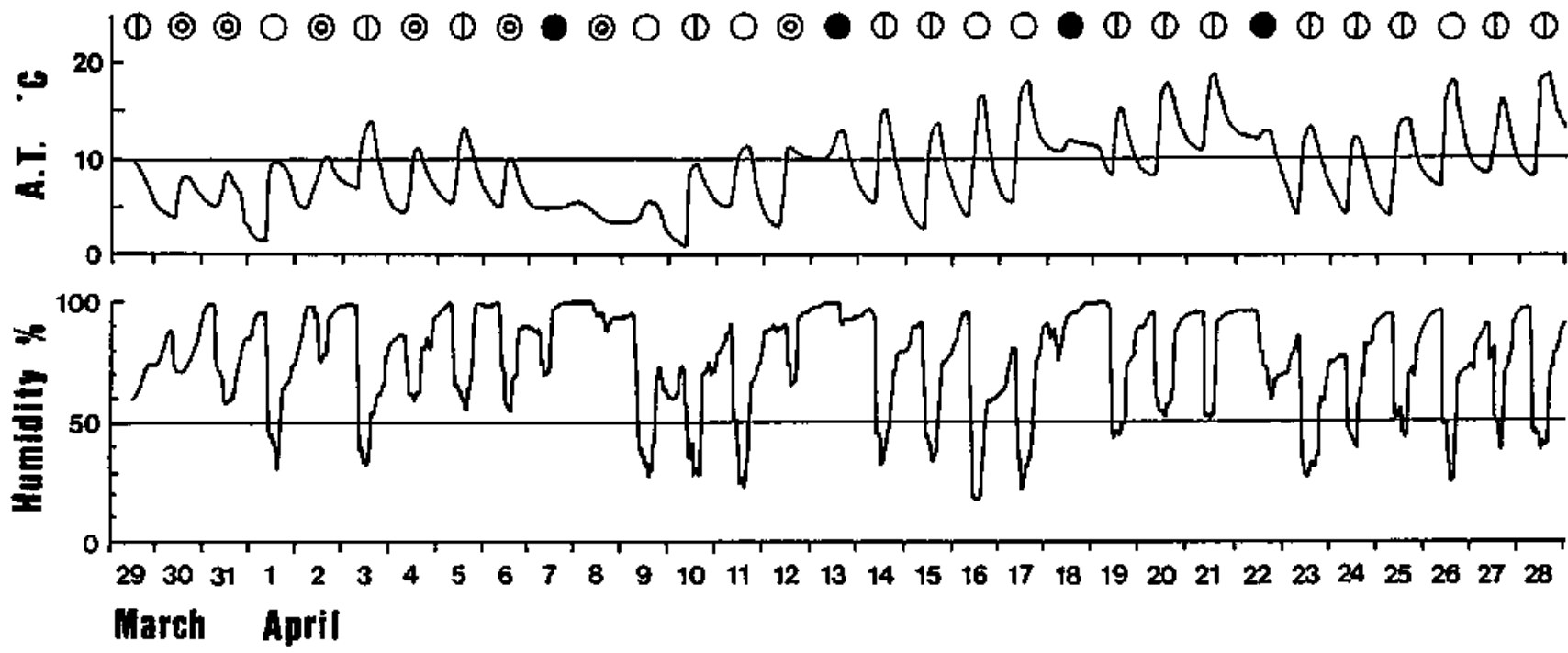

Fig. 1

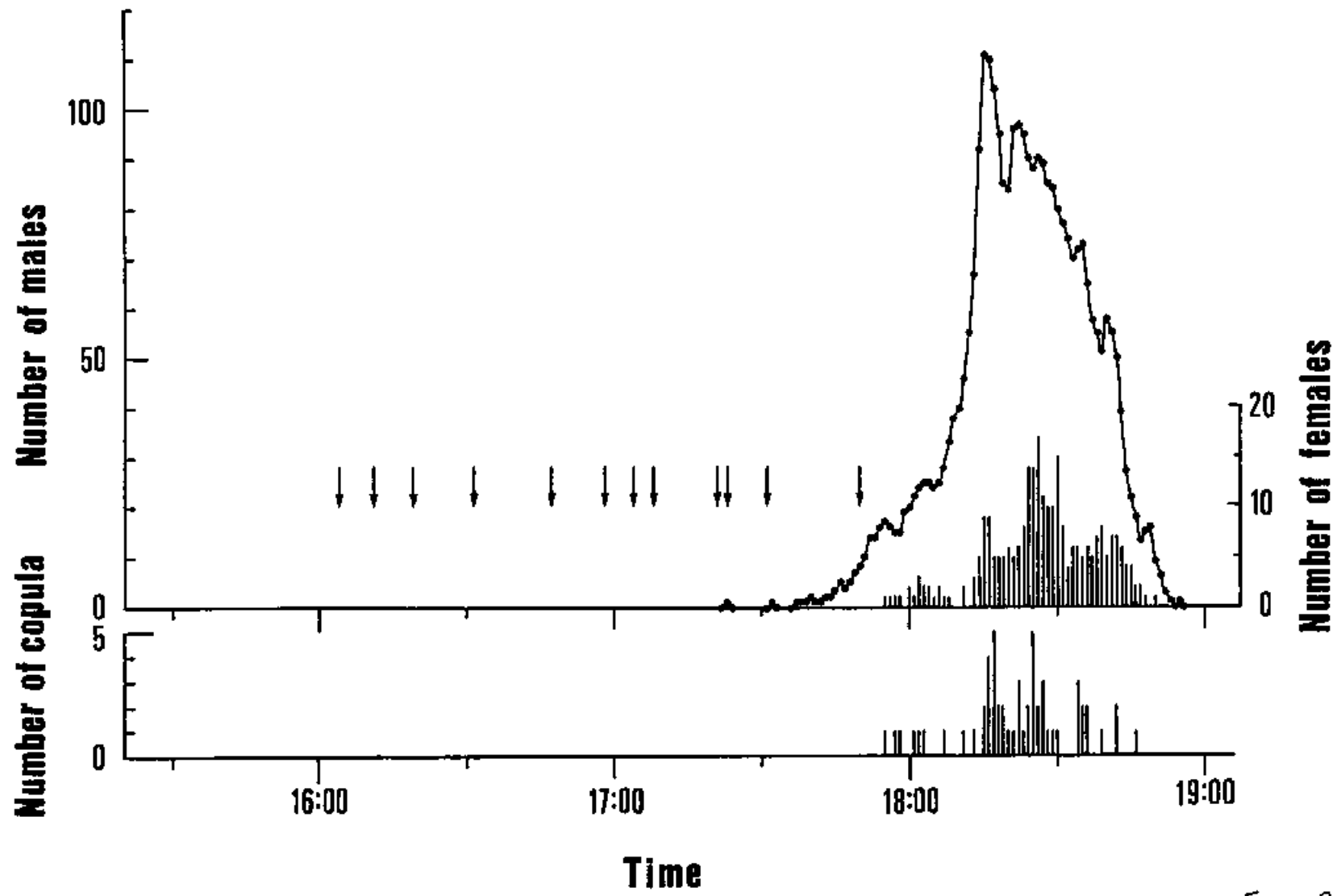
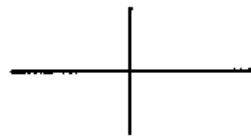
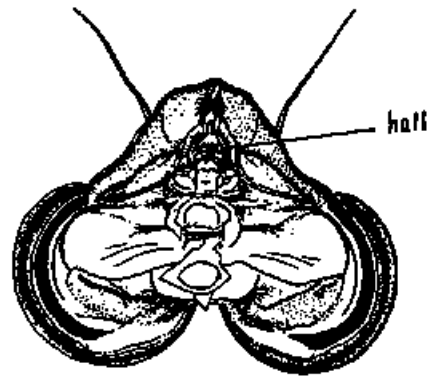
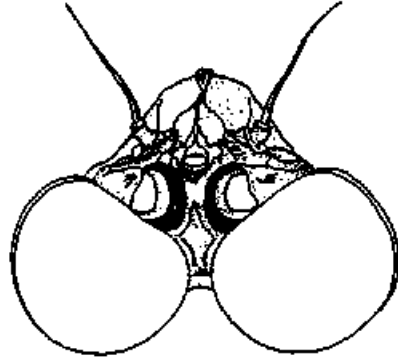
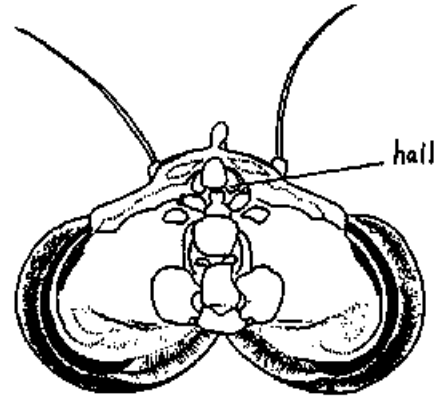
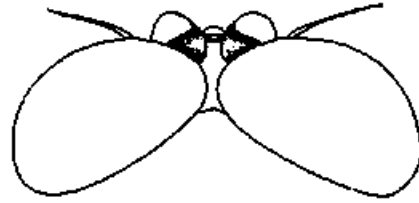

Fig 2

(a)



(b)



0 1 mm

Fig 3

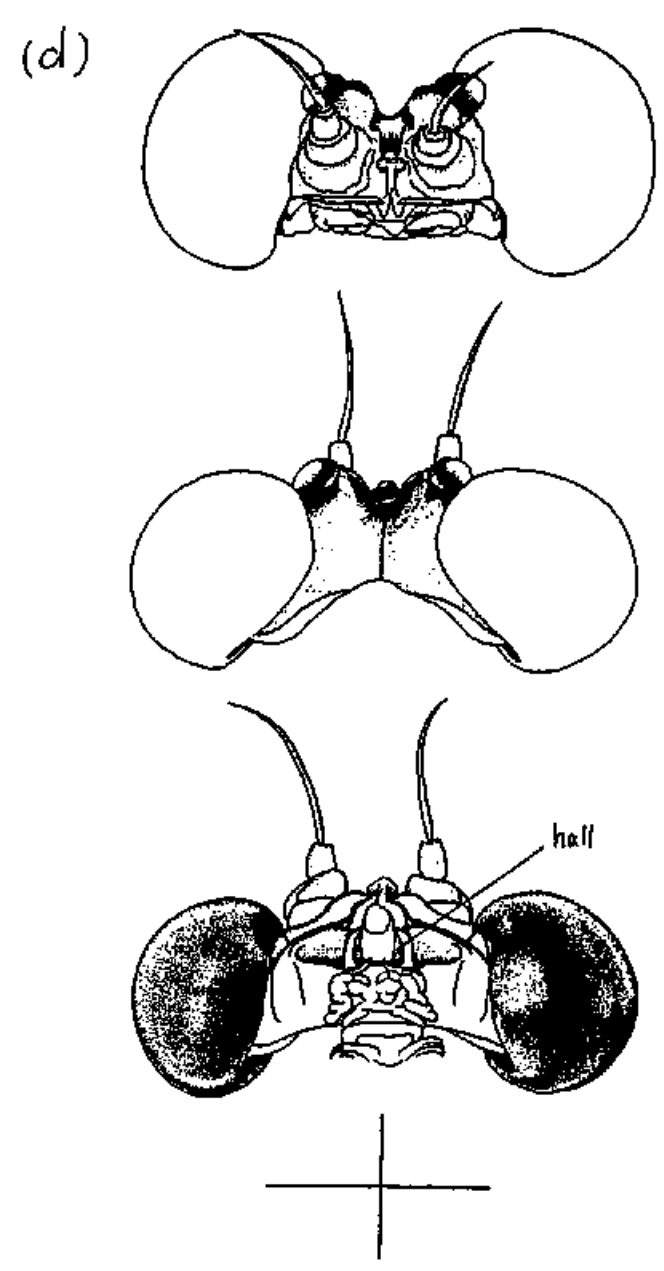
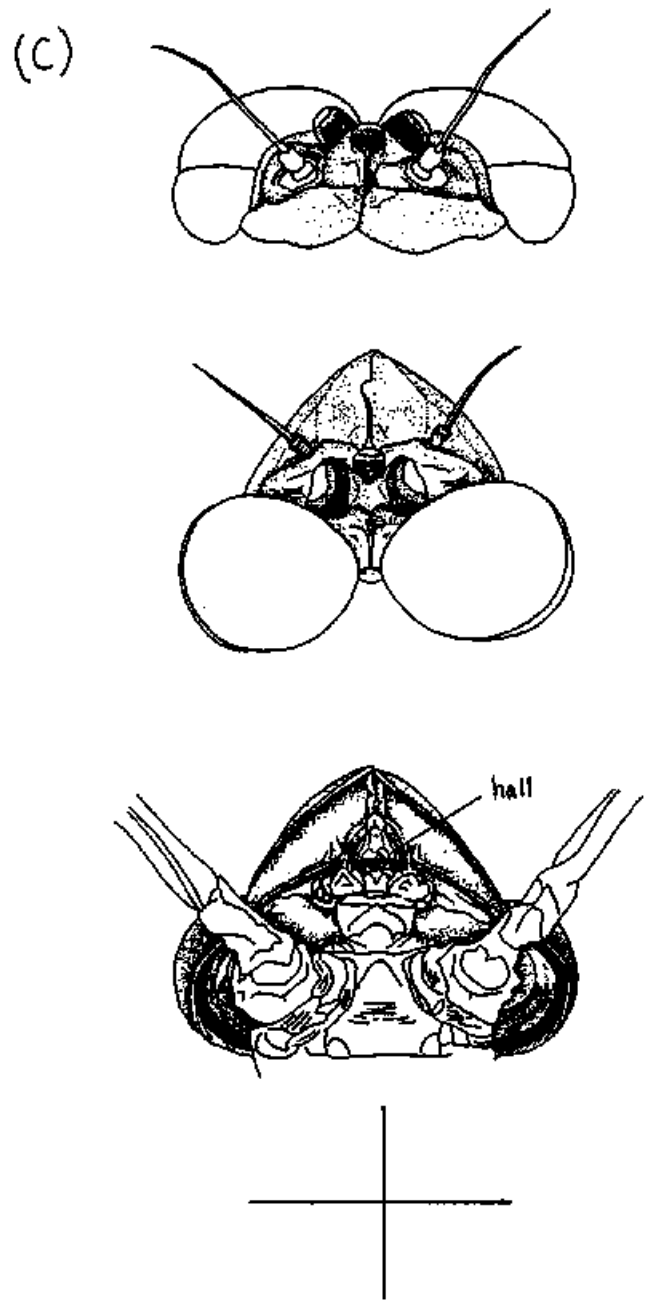

0 1 mm

Fig. 3

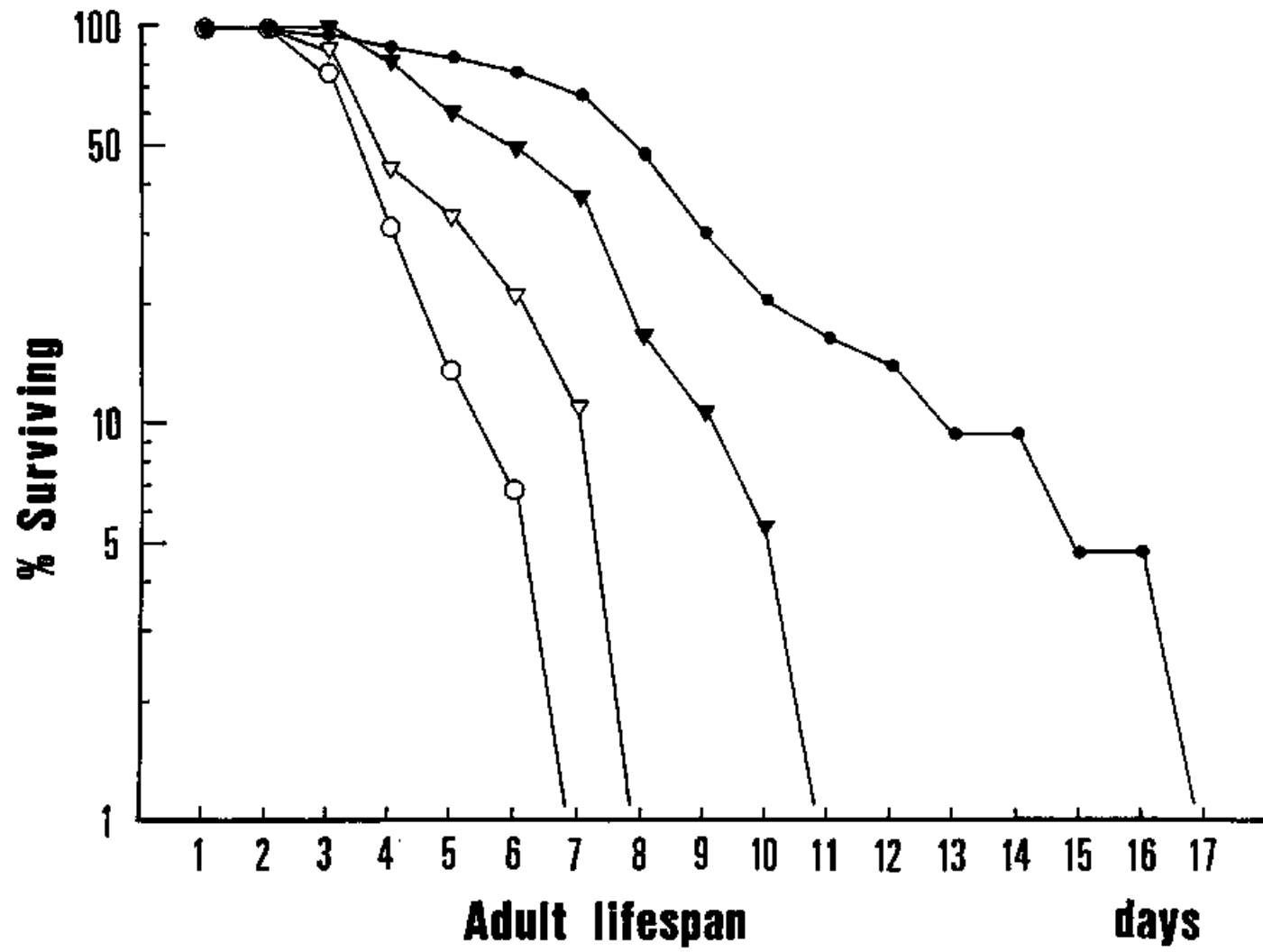

Fig 4

Male assembly on the ground for mate location in the mayfly  
Epeorus ikanonis (Ephemeroptera: Heptageniidae)

Running headline: Male assembly in Epeorus ikanonis

YASUHIRO TAKEMON

Department of Zoology, Faculty of Science, Kyoto University,  
Kyoto, 606 JAPAN

Abstract. In addition to the normal swarming in the air in this family, adult males of the heptageniid mayfly Epeorus ikanonis Takahashi also congregate in large numbers (an assembly) on the stream shore for mate location. Males in the assembly copulate with walking females on the ground usually for more than six minutes. The reproductive behaviour of this species was described, and the evolutionary factors for the male assembly and the long copula duration were discussed in relation to following three properties of this species : 1) the multiple copulation of females and a chance of fertilization for the sperm from successive copulation, 2) concentrated distribution of oviposition sites at the shore within male assemblies, and 3) a mate recognition through body touching, which allows males to gather at high densities. A general discussion on phylogenetic relationships and factors for the determination of mate location sites in mayflies was attempted.

Since insects exhibit a diversity of mate location sites, such as emerging sites, foraging sites, oviposition sites, hibernation sites, and land mark sites, the mate location behaviour has been regarded to be evolutionally labile (Thornhill & Alcock 1983). Within certain orders a considerable variation in mate location behaviour can exist: e.g., Odonata (Waage, 1984), Lepidoptera (Drummond III 1984), or Diptera (Downes 1969; Pritchard 1983). Conversely, in the Ephemeroptera, the mating systems have been typified by swarming, and differences have been known only within this swarming behaviour (Brodsky 1973; Grandi 1973; Savolainen 1978). As a result, mayflies have been believed to have only the simple method of mate location by swarming, because of the simple morphology of the reproductive organs and the short longevity of the adult stage (Thornhill & Alcock 1983; Eberhard 1985).

The heptageniid mayfly Epeorus ikanonis Takahashi inhabits the upper to middle reaches of streams in Japanese low mountains (Kani 1944), and has a univoltine life cycle, emerging in early spring (Gose 1970). The reproductive behaviour of this species, described in the current paper, is strikingly different from that known generally for mayflies. Firstly, males of this species congregate in large numbers on the stony shore of the stream in order to locate mates. They are so aggregated in a particular area that a mass of them can be detected as an assembly. Secondly, copulation occurs on the ground, initiated by the assembly male with a walking female and last for more than six minutes on average, which is exceptionally long in mayflies. Thirdly, females show a high frequency of multiple copulation. Fourthly, the oviposition sites are restricted to the shore inside the male assembly.

The present paper aims to discuss evolutionary reasons of the assembling behaviour of males and the long copula duration of this species. Scramble competition polygyny forming a mating assembly at oviposition sites has been known also in some species of damselflies, and has been attributed to the even distribution of the oviposition sites (Thornhill & Alcock 1983) and to high density of males (Pajunen 1966; 1980; Higashi et al. 1987). Since the oviposition sites of this species are concentrated at the restricted shores, other evolutionary reasons are needed, and thus, are discussed in relation to the influence of sperm competition, distribution of receptive females, and the mate recognition method.

## METHODS

### Study Site

The study was conducted at the middle reaches of the Kibune Stream (35° 0' N, 130° 0' E), a tributary of the River Kamo, which runs through Kyoto City. An observation area was established at Yuyaga-dani-deai (elevation 350m) where the stream forms a mountain torrent with a series of rapids and pools (Fig.1a). The bankside vegetation of this area was composed of the <sup>cultivated</sup> artificial forest of Japanese cedar Cryptomeria japonica and the secondary deciduous forest. The general features of the Kibune Stream have been described by Tanida (1980) and Takemon (1985).

### Observation of Reproductive Behaviour

The mayfly formed assemblies at the open shore of a rapid area

where pebble or sand had accumulated on the shore, and the males also formed swarms in the air at the open space mainly above the stream (Fig.1b). The attendance of males in each assembly and swarming site was recorded within the observation area daily from 7 to 25 April, 1986 and on 15 and 16 April, 1987. One of the assembly sites was divided into 10 X 10 cm grid sections (see Fig.4) and the numbers of males, mating pairs and ovipositing females in each grid were counted at several minutes intervals on 14 April 1986. Time spent by females in each behaviour of reproduction was recorded from their arriving at the assembly site to flying away from 12 to 25 April 1986.

## RESULTS

### Assembling Behaviour of Males

During the study period five assemblies (A-E) were found in the study area (Fig.1b). Distribution of them corresponded to the rapid shore with pebble or sand above which was open without bush canopies. Males conducted a short hovering flight just above the water's edge before landing on the shore. Males remained at the position in which they landed, and showed no territorial and aggressive behaviours. When the male density increased, males sat in two or three layers on the ground. When a male began to move, its neighbours responded by moving a short distance, but the degree of crowding did not decrease after they became stationary.

The location of assemblies remained constant within a season and even between years (Table I). At site C and E the number of individuals was greater than at the other sites and males attended

the sites C and E on all days when the reproduction was observed (Fig.2). In each assembly, a large number of males sat stationary on the ground and a number of females copulated and oviposited there. At site C, 1185 males were found sitting within an area of 2.0 m in length and 0.7 m in width on 17 April 1986. A correlation was found between the daily maximum number of females and males in each assembly (total number of females-males:  $r=0.94$ ,  $P<0.001$ ; ovipositing females-males:  $r=0.93$ ,  $P<0.001$ ; copulating females-males:  $r=0.80$ ,  $P<0.005$ ;  $N=13$  for each combination).

#### Swarming Behaviour of Males

Swarming males were found at the open space above the stream, banks, and the road along side the stream. Although swarms were vague in shape and extent, three core sites could be detected above the stream (Fig.1). The location of these sites was fixed through a season and years (Table I). Each male stayed in the air at a height of 2 m to 10 m hovering with a vertical undulation irregularly. The mean frequency of undulation was 13.5 times per minute ( $N=8$ , range=10-18). When the number of males at a core site was less than a dozen, most individuals hovered in a dispersed fashion above open riffles. When the number of males increased to more than a dozen, they dispersed over the streams and banks and the boundaries of a swarm became obscure.

#### Mating Behaviour

Mating occurred in two ways: it was commenced by the assembly males with females walking on the ground, or by the swarming males in the air. Females arrived at the assembly site sporadically in

the daytime, landing after a short hovering above the shoreline at a height of several centimetres. Females walked intermittently after landing. Males were rather indifferent towards females flying above or walking a part from males. However, once a female closed to a male as near as touching each other, the male chased the female quickly with his abdomen held upward, crept under the female from behind, seized the body with the fore-legs, and then copulated. The copula duration averaged 7'03" (N=32, range=1'06"-15'53", SD=4'00"). During the early part of copulation (30-50 seconds after pairing) males exhibited prominent peristalses of the abdomen. The peristalsic action itself took only 2-4 seconds. In most cases, copulation was terminated by the female walking, but male-induced termination was also observed.

When an assembly male was stimulated by body contact with a female or by already stimulated walking males, he started to chase a moving individual, even if it was a male or another mayfly species, such as Ecdyonurus tobiironis. When it was a male of E.ikanonis or E.tobiironis, he released it immediately after seizing with his claspers, but when it was a female of E.tobiironis, copulation was continued for more than 10 minutes. Intermale body contact seldom released copulation behaviour when females were absent. When a female walked dragging a mate during copulation, neighbouring males gathered behind the pair and linked to each other by seizing the fore male with the clasper. A maximum of four males with one female was observed, but the following males abandoned their attempt during the copulation of the first male. A successful take-over by the second male was observed only once in 95 observations.

After the copulation in the assembly site, some females copulated twice sequentially with another male. The female response to the secondary male was to attach the abdomen on the substrate by sinking her body, which looked like refusing males. This posture was also observed sometimes at the first copulation in the assembly but the ratio of females presenting this posture was not measured. However, almost all males succeeded in copulation irrespective of the posture once catching up with the female (98%, n=53).

Swarming males chased an object flying straight horizontally in a swarm even if it was a stone thrown by the observer. When it was a conspecific male or a female of another species such as Ameletus costalis, the male released it after seizing it in the air. Copulation occurred only with females flying across the swarm horizontally at the height of swarming males ranged from 2m to 10m. Once the flying females descended lower than this height, the males did not chase them at all. After a male seized a female, the pair descended and landed on the ground or vegetation. The copulation always occurred on the substrate. The copula duration of swarming males ( $X=5'02"$ , range= $1'35"-10'25"$ ,  $SD=3'10"$ ,  $N=10$ ) was slightly shorter than that of assembly males ( $P<0.005$ ).

#### Ovipositing Behaviour

Ovipositing females were found only at the shore within assemblies. Before oviposition, females walked quickly pausing frequently. When they encountered a water-logged area between stones, they reversed their body to the water until the abdomen was submerged and touched the body on the substrate by folding

their legs. After a short time (5"-4'42") they warped the abdomen upward out of water, extruded an egg-mass on the tip of the abdomen, and then released it in the water. They repeated the extrusion and release of an egg-mass an average of 10.2 times (N=18, range=2-21) at the same site at 45.4 second intervals (N=129, range=16"-139"). The eggs in an egg-mass scattered into the water after the release, facilitated by the smooth egg surface. Following such procedure, all females flew away. Examination of the oviducts of 14 females leaving the oviposition sites revealed them to be always empty, indicating them to have oviposited all their eggs at one site. Duration from the start of oviposition to flying away was 6'35" on average (N=36, range=3'30"-18'04").

#### Flow Diagram of Female Behaviour

Fig.3 shows a flow diagram of the reproductive behaviour of females. Of 11 females pairing with swarming males in the air, 18% landed inside the assembly, whereas 82% did so out of the assembly, while of 121 females landing at the assembly site, 7% were pairs and 93% were single. As pair arrival was more conspicuous than single arrival, the percentage of the former could be an overestimation. In the case of 89 single arrivals, 48% of females copulated with assembly males and 52% oviposited. Of 53 females pairing in the assembly, 2% rejected copulation and oviposited, 9% flew out of the assembly with a mate male. 89% completed copulation in the assembly. Of 43 females after copulation, 67% started oviposition successively, 21% flew out of the assembly, and 12% copulated again with another male. Of five

females finishing the second copulation, 80% oviposited and 20% flew away. The average duration from separation to oviposition and to flying away was only 20 seconds ( $n=33$ , range=0'02"-1'20") and 46 seconds ( $N=9$ , range=0'01"-4'38"), respectively. Of 38 females starting oviposition, 5% were seized by assembly males in spite of the oviposition posture at the water's edge. In these cases, males accomplished copulation spending a normal copula duration (range=5'02"-10'53"). Of 36 females after oviposition, 97% flew away toward the bank, and 3% paired with a male but the pair separated soon (0'09"). Although not all traced females remained at the assembly site after oviposition, several spent females were found there at the end of daily observations.

#### Distribution of Males, Copulation Sites and Oviposition Sites in the Assembly

Distribution of males, copulating pairs and ovipositing females were analysed based on 22 series/sets of observations on 14 April 1986. Males were concentrated near the water's edge (Fig.4a). The mean density ( $m$ ) of males was 5.0 per grid (100 cm<sup>2</sup>). The calculation of Lloyd's (1967) mean crowding ( $\bar{m}^*$ ) resulted in 19.4 males per male per observation, and thus the value of  $\bar{m}^*/m$  was 3.88. The relation of  $\bar{m}^*$  to  $m$  of each observation showed a linear correlation (Fig.5a), which indicates a concentrated type of distribution (Iwao 1968). However,  $\bar{m}^*/m$  decreased with the increase of  $m$  (Fig.5b) showing that males tended to gather around the higher density sites and thus the degree of concentration decreased in spite of higher values of  $m$ .

Distribution of the copulation sites in the assembly is shown

in Fig.4b. Copulating pairs were observed 262 times in 49 grids. The mean copulation density ( $m$ ) in 93 grids was 0.127 times per grid per observation, the mean crowding ( $\bar{m}^*$ ) was 0.484 times per time per observation, and thus the value of  $\bar{m}^*/m$  was 3.81 which also indicated a highly concentrated distribution.

Since the water-logged area between stones suitable for oviposition was restricted to the sections beside the shoreline, oviposition sites were more concentrated than male aggregations and the copulation sites (Fig.4c). Ovipositing females were observed 176 times in 33 grids. The mean oviposition density ( $m$ ) in 93 grids was 0.086 times per grid per observation, the mean crowding ( $\bar{m}^*$ ) was 0.516 times per time per observation and thus the value of  $\bar{m}^*/m$  was 6.00.

The density of males, copulation sites and oviposition sites were all highly correlated with each other (Fig.6). Due to the higher concentration of the oviposition sites, the relation of oviposition density to male density had a higher regression coefficient than that of copulation density to male density. It therefore follows that most oviposition occurred in the grids of high male density: e.g., 75% of oviposition occurred in the grids where contained more than 2.5% of all males. However, many copulations occurred in the grids of low male density: e.g., 41% of copulations occurred in the grids with males under 2.5% of the total each. As a result, the number of copulation per male was rather equal among grids irrespective of the male density (Fig.6b), agreeing with an ideal free distribution of copulation frequency of males (Fretwell 1972).

## DISCUSSION

The mating systems of mayflies are characterized by a nuptial flight or a swarm (Needham et al 1935; Spieth 1940; Brinck 1957; Brodsky 1973; Grandi 1973; Savolainen 1978; Brittain 1982) and variations in swarming behaviour have been traditionally considered as due to the difference of swarming site, swarm marker, flying manner, and diel periodicity (Brodsky 1973; Grandi 1973; Savolainen 1978; Allan & Flecker 1989). As a result, the mate location sites of mayflies are recognized to be related with the land mark for swarming (Savolainen 1978; Allan & Flecker 1989). Allan & Flecker (1989) examined the relations of swarming sites to emerging sites and to oviposition sites for the mayfly Epeorus longimanus, and then proposed that the swarming behaviour of the species has evolved to facilitate mate location and mate choice by female preference for specific landmarks. Mate location behaviour at unrelated landmarks to any resource for a species seems likely to be evolved by female preference to a particular site in case of dispersed distribution of receptive females which prevents them from encounter with mates (Thornhill & Alcock 1983). However, the distribution of receptive females has never been studied in mayflies. Moreover, female receptivity and the value of a female as a mate for males are changeable according to female experience and types of sperm competition (Parker 1970). Thus, it should be took into account for the evolutionary considerations on mate location sites whether the multiple copulation occurs, how much the P2 value (sperm precedence value) is, and where and when the advantageous females are distributed. After the examination of

these factors, the relations of the mate location sites to the emerging sites, oviposition sites or other specific sites will be able to be properly discussed.

#### Multiple Copulation of Females

Mayfly females have been generally assumed not to remate since their lives are very short, without evidence, though (Eberhard 1985) On the other hand, there have been some single observations on remating of mayflies for Epeorus assimilis and Cloeon simile (Degrange 1960), but any quantitative studies have never made before. Females of Epeorus ikanonis exhibit remating even during their staying at an assembly just before oviposition. Although 12% of mated females showed remating at the assembly site, frequency of multiple copulation through lifetime should be more since landing females might have mated with swarming males before arriving at the assembly and since 21% of females take off after copulation in the assembly and they will again land on one of the assemblies in order to lay eggs. As a result of female multiple copulation, P2 value becomes of importance for male reproductive success gained from a copulation, which may affect male preference to virgin females, non-virgin ones or both.

#### Influence of Sperm Competition

Coincidence of the distribution of the assembly sites and the oviposition sites indicates that the assembling behaviour of males is a sit-and-wait tactic for mate location at the oviposition sites. In the evolution of this mate location behaviour, the possibility of fertilization by a successive copulation seems to

have been an indispensable factor, considering the high frequency of female multiple copulation. When males can gain success by a copulation with non-virgin females, it becomes worthwhile to locate them coming to lay eggs.

Takemon (in press) found that females of this species have modified oviducts with a seminal receptacle which retains the sperm until oviposition and that the sperm of a successive copulation is probably stored in the vestibule. The sperm in the vestibule is likely to be used first but seems apt to be washed out with eggs. Thus, P2 value of this species seems to be greater than zero, but not a high value. The habit of assembly males to copulate with non-virgin females is consistent with the gain of some benefit from successive copulations of a female.

The copula duration of E.ikanonis is exceptionally longer than that of most species of mayflies which is usually less than a minute (Table II). This long copula duration seems to function as mate guarding. When the successive copulation gains some success, the male can ensure a higher reproductive success by keeping the copulation posture until his mate shows signs of starting oviposition. This hypothesis is partially supported by the duration from the separation of a pair to the start of oviposition as short as 20 seconds on average. The peristalses of male abdomen during the earlier part of copulation seem to reflect the sperm ejaculation, considering the frequent occurrence of ejaculated sperm in the female reproductive organs as early as one minute after the start of copulation (Takemon in press). Continuation of the copulation posture even after this period is unlikely to be advantageous for males if not regarding it as mate guarding. The

shorter copula duration of swarming males than that of assembly males might be derived from the uselessness of mate guarding, because the mate should visit the assembly for oviposition in future and she might remate there irrespective of the copula duration of swarming males. If it is true, why not the swarming males accompanied the mates to assembly sites until oviposition, as same as the tandem tactic of damselflies found by Ueda (1979)? Further examination of the cost and benefit of mate guarding (Parker, 1974) is required to answer this question.

#### Distribution of Oviposition Sites

Despite the fact that the sperm storage organs exist in females of the families Heptageniidae, Siphonuridae, Ephemerellidae and Leptophlebiidae (Brinck 1957), male assembly has never been found among them. This may be related to their oviposition habits. Most species of these families oviposit on the water surface (Needham et al. 1935; Degrange 1960). Although the habit of oviposition at the water's edge has been reported for some species of the genera Ecdyonurus, Rhithrogena, and Habroleptoides (Elliott & Humpesch 1980; Brittain 1982), the concentration of oviposition sites at a shore of the stream has never before been reported.

Females of E.ikanonis lay eggs only at the rapid shore with pebble and sand above which is open without bush canopies. And, thereby, the distribution of oviposition sites was restricted to only five sites within 35m stretch of the stream. The concentrated distribution of oviposition sites seems to facilitate the evolution of the assembling behaviour only if  $P^2$  value is more than zero. Male reproductive success is influenced not only by the

benefit from one copulation but also by the number of copulations achieved. Thus even if P2 value is low, mate location at oviposition sites can become advantageous particularly when their distribution is concentrated.

In case of above four families, the sit-and-wait tactic may be meaningless for the species which females lay eggs on the water surface and the males will take a hover-and-wait tactic above the water where females prefer for oviposition. Therefore, the sit-and-wait tactic may be restricted to those species which females oviposit at the shore of streams, such as a part of the members of Heptageniidae and Leptophlebiidae. In conclusion, among the mayfly species with the sperm storage organs in females, the oviposition habits seem to affect the mate location behaviour of males.

#### Relations to the Emerging Sites

Mate location on the ground is also known among species of chironomids (Downes 1969; Kon et al. 1986), tabanids (Matsumura 1984) and tipulids (Downes 1969; Zalom 1979). In those species it is not connected with the oviposition sites but with the emerging sites: e.g., males of some chironomids search for mates on the substrate near the shore where emerging females come to rest (Kon et al. 1986) and males of some tipulids form assemblies on the vegetation beside the emerging sites to catch emerging females (Zalom 1979). For most mayflies, however, the location of emerging females is not advantageous because they emerge in an immature stage of subimagines, which moult into the reproductive stage after dispersing from the emergence sites. Allan & Flecker (1989) revealed that there was no relationship between the swarming sites

and the emerging sites in the mayfly Epeorus longimanus. Although mate location sites in mayflies have been generally connected with emergence sites (Thornhill & Alcock 1983), they may be important only for the species which female is extremely short lived and reproduces in the subimaginal stage, such as members of Polymitarcidae.

#### Mate Recognition Method of Assembly Males

The assembly males of E. ikanonis chase females by walking rapidly on the ground when they copulate. Thus the ability for rapid walking is required for the mating tactic of assembly males. The nymphal body form of the heptageniid species is very flat so as to walk on the surface of stones (Imanishi 1938). This property seems to remain in the adult stage of those species, which may be a preadaptation for the establishment of the male mating behaviour in the assembly.

The behavioural process of copulation indicates the releaser of copulation behaviour is an individual walking quickly beside him. When a female walked several centimetre apart from assembly males, they did not chase her and sat stationary. This frequent failure of mate recognition seems to let females oviposit without copulation after arriving the assembly site in high ratio as 52%. Although this might be a factor enabling the swarming tactic of males in the same population, diel and seasonal change of each mate locating behaviour should be examined in order to clarify the reason of alternative mating behaviour of this species.

In general males of explosive mating assemblage belonging to scramble competition polygyny make no effort to defend a mating

territory but instead outrace their competitors to receptive females (Emlen & Oring 1977), and which is exemplified by some damselflies showing even distribution of oviposition sites (Thornhill & Alcock 1983) or high density of males around the oviposition sites (Pajunen 1966; 1980; Higashi et al. 1987) Assembly males of this mayfly lack territoriality and also any aggressive behaviours. These properties may be attributed to not only high density of males but also the mate recognition method. In this species, when a male moves carelessly, he will be seized by another male, and he will lose time and effort as a result. This may be the reason why males stand still in the assembly until females come across them by chance, and thereby, males gather at high densities at oviposition sites. The copulation frequency of assembly males agreeing with an ideal free distribution (Fretwell 1972) may be attributed to the method of mate recognition which enable males to choose landing sites at the oviposition sites irrespective of the male density.

Flecker et al. (in press) document that large males gain a disproportionate share of matings in Epeorus longimanus and this result is derived from male-male competition which may facilitate mate choice by females. In the assembly of E.ikanonis, however, both male-male competition and mate choice by females are not prominent considering the males waiting mates passively without aggressiveness, very low ratio of successful take-over, and the copulation frequency of males following an ideal free distribution which guarantees males at each site of the assembly to gain mating success evenly.

## Relation to Phylogeny

According to the phylogenetic investigations based on the external morphology of male adults and mature nymphs, and on the internal anatomy of the nymphs, it is widely believed that the family Heptageniidae is derived from the ancestral lineage evolved from pre-Isonychia species (Edmunds, 1972; 1973; Jensen, 1972; Edmunds et al., 1976). Although there has been another opinion that Heptageniidae is allied to Leptophlebiidae (Demoulin, 1958), it is generally accepted that the former is rather isolated and apomorphic family in Ephemeroptera (Thernova; 1970; Riek, 1973; Edmunds, 1972). The genus *Epeorus* has been considered to be also an apomorphic one within a phyletic line of this family (Jensen, 1972). Considering that only swarming behaviour has been reported for the mate location method in mayflies including the derived genus *Cinygmula* (Lehmkuhl & Anderson, 1970) and *Isonychia* (Clemens, 1917; Cooke, 1942), and the derived family Siphonuridae (Clemens, 1913; Edmunds et al., 1976), the sit-and-wait tactic for mate location seems to be evolved after the normal swarming behaviour.

## Mate Location Behaviour in Mayflies

This study reveals that the mate location behaviour of mayflies is more diverse than just swarming and the main factors for the evolution of sit-and-wait tactic at oviposition sites may be both possibility of fertilization for successive copulation and the concentration of oviposition sites. Meanwhile, mayflies show much diversity in the morphology of female reproductive organs, ranging from a simple form of oviducts opening directly to gonopores to

strongly modified forms with the vestibule, a seminal receptacle, and copulatory pouches (Brinck 1957). And thus, P2 value of mayflies may differ among species according to the morphological variations (Takemon in press): i.e., the eggs of mayflies with non-modified simple gonopores such as Ephemeridae and Baetidae are presumably fertilized by the sperm traveling into the oviducts, and therefore P2 value of these species is expected to be as low as zero, and the eggs of mayflies with modified gonopores with sperm storage organs such as Heptageniidae, Siphonuridae, Ephemerellidae and Leptophlebiidae may be fertilized by the sperm reserved until oviposition, and thus P2 value is possible to be more than zero. As a result of difference in P2 values, males of the former families is expected to locate virgin females in order to raise their reproductive success and those of the latter families might locate also non-virgin females in case of their concentrated distribution. Therefore the mate location sites of the former families may be decided irrespective with the distribution of oviposition sites but for the former families it may be of importance in the determination of mate location sites.

Speculated relations of the morphological variations in female reproductive organs to the mate location sites indicate that evolutionary reasons of swarming sites in mayflies are also varied according to the types of sperm competition nevertheless the swarming sites themselves are common among species; e.g., swarming behaviour above streams might be conventional encounter sites derived from female preference for the place (Parker 1978) in case of species which P2 value is zero, while it might be derived from oviposition habits on the water surface in case of species which

P2 value is more than zero. When the density of individuals in a population is very low, however, the former possibility might be probable as mentioned by Sullivan (1981) irrespective with P2 ratio. Swarming behaviour forming a "true swarm" (Sullivan 1981) at land marks which are not related to any resources for females seems to be facilitated by the female preference.

#### ACKNOWLEDGMENTS

I wish to thank Prof. Hiroya Kawanabe and Drs. Andrew Rossiter and Takuya Abe, Dept. Zoology, Kyoto University for their critical reading of this paper, Prof. David L. G. Noakes, Dept. Zoology, University of Guelph, Dr. Kazumi Tanida, Dept. Life Sciences, University of Osaka Prefecture, Dr. Takayoshi Nishida, Dept. Agriculture, Kyoto University, and Tetsuyuki Ueda, Laboratory of Natural Sciences, Ishikawa Agricultural College, for their helpful comments on the earlier draft of this paper, Mr. Kosaburou Torii for kindly allowing my access to his property for the field work, and members of the Laboratory of Animal Ecology in Kyoto University for their critique on the current work. This study is partially supported by the Grand-in-Aid of Scientific Research (Nos. 57480006 and 61480005), for Cooperative Research (No. 62304003) and for Special Project Research on Biological Aspect of Optimal Strategy and Social Structure (Nos. 58121004, 59115504 and 6107092) from Japan Ministry of Education, Science and Culture. This work is the contribution from the Laboratory of Animal Ecology, Kyoto University, No. 502.

## REFERENCES

- Allan, J. D. & Flecker, A. S. 1989. The mating biology of a mass-swarming mayfly. Anim. Behav., 37, 361-371.
- Brinck, P. 1957. Reproductive system and mating in Ephemeroptera. Opusc. Ent., 22, 1-37.
- Britt, N. W. 1962. Biology of two species of Lake Erie mayflies, Ephoron album (Say) and Ephemera simulans Walker. Bull. Ohio Biol. Surv., 1, 1-72.
- Brittain, J. 1982. Biology of mayflies. A. Rev. Entomol., 27, 119-147.
- Brodsky, A. K. 1973. Swarming behaviour of mayflies (Ephemeroptera) Entomol. Rev. USSR, 52, 33-39.
- Clemens, W. A. 1913. New species and life histories of Ephemeridae or mayflies. Canad. Entomol. 45, 246-262, 329-41, 3pls.
- , 1917. An ecological study of the mayfly Chirotentis. University of Toronto Studies. Biological Ser., No.17, 1-43, 5 pls.
- Cooke, H. G. 1940. Observations on mating flights of the mayfly Stenonema vicarium. Entomol. News, 51, 12-14.
- , 1942. Mating flights of Isonychia mayflies (Ephemeroptera). Entomol. News, 53, 249-252.
- Degrange, C. 1960. Recherches sur la reproduction des Ephemeropteres. Trav. Lab. Hydrobiol. Piscic. Grenoble, 51, 7-193.
- Demoulin, G. 1958. Nouveau schema de classification des Archodonates et des Ephemeropteres. Bull. Inst. Roy. Sci. Nat. Belg. 34 (27), 1-19.
- Downes, J. A. 1969. The swarming and mating flight of Diptera.

A. Rev. Entomol., 14, 271-298.

- Drummond III, B. A. 1984. Multiple mating and sperm competition in the Lepidoptera. In: Sperm competition and the evolution of animal mating systems. (Ed. by R. L. Smith), pp.291-370. Orland: Academic Press, Inc.
- Eaton, A. E. 1983-88. A revisional monograph of recent Ephemeridae or mayflies. Trans. Linn. Soc. London 2d Ser. Zool., No.3.
- Eberhard, W. G. 1985. Sexual Selection and Animal Genitalia. Cambridge: Harvard University Press. 244pp.
- Edmunds, G. F. Jr. 1972. Biogeography and evolution of Ephemeroptera. A. Rev. Ent. 17, 21-42.
- , 1973. Some critical problems of family relationships in the Ephemeroptera. In: Proceedings of the First International Conference on Ephemeroptera. (Ed. by W. L. Peters & J. G. Peters), pp.145-154. Leiden: E. J. Brill.
- Edmunds, G. F. Jr., Jensen, S. L. & Berner, L. 1976. The Mayflies of North and Central America. 330pp. Minneapolis: Univ. Minn. Press.
- Elliott, J. M. & Humpesch, U. H. 1980. Eggs of Ephemeroptera. Ann. Rep. Freshwater Biol. Assoc., 48, 41-52.
- Emlen, S. T. & Oring, L. W. 1977. Ecology, sexual selection, and the evolution of mating systems. Science, N.Y., 197, 215.
- Flecker, A. S., Allan, J. D. & McClintock, N. L. In press. Swarming and sexual selection in a Rocky Mountain mayfly. Holarctic Ecol.
- Fretwell, S. D. 1972. Populations in a Seasonal Environment. Princeton, New Jersey: Princeton University press. 217pp.
- Gose, K. 1970. Life histories of some species of Ephemeroptera and

- Plecoptera at Ikadaba in the Yoshino River.  
Productivity of the Yoshino River, 2, 8-13. (In Japanese)
- Grandi, M. 1973. I comportamenti di volo nelle diverse fasi della vita area degli Efemerotteri. Boll. Inst. Ent. Univ. Bologna, 31, 109-127.
- Higashi, K, Ubukata, H. & Tsubaki, Y. 1987. Dragonfly Mating Systems. Tokyo: Tokaidaigaku-shuppankai, 318pp. (In Japanese)
- Imanishi, K. 1938. Mayflies from Japanese torrents IX. Life forms and life zones of mayfly nymphs. I. Introduction. Annot. Zool. Japon., 17, 23-36.
- 1945. Mayflies. In: Nihon Seibutsu-shi. 5. Konchugekan. (Ed. by H. Furukawa), pp405-434. Tokyo: Kenkyu-sha. (In Japanese)
- Iwao, S. 1968. A new regression method for analyzing the aggregation pattern of animal populations. Res. Popul. Ecol., 10, 1-20.
- Jensen, S. L. 1972. A Generic Revision of the Heptageniidae of the World (Ephemeroptera). 264pp. Ph.D. Thesis. Univ. Utah.
- Kani, T. 1944. Ecology of torrent-inhabiting insects. In: Insects. I. (Ed. by H. Furukawa), pp.171-317. Tokyo: Kenkyuu-sha. (In Japanese)
- Kon, M., Otsuka, K. & Hidaka, T. 1986. Mating system of Tokunagayusurika akamushi (Diptera:Chironomidae): I. Copulation in the air by swarming and on the ground by Searching. J. Ethol., 4, 49-58.
- Lehmkuhl, D. M. & Anderson, N. H. 1970. Observation on the biology of Cinygmula reticulata McDunnough in Oregon (Ephemeroptera

- : Heptageniidae). Pan-Pac. Entomol. 46, 268-274.
- , 1971. Contributions to the biology and taxonomy of the Paraleptophlebia of Oregon (Ephemeroptera:Leptophlebiidae). Pan-Pac. Entomol., 47, 85-93.
- Lloyd, M. 1967. 'Mean crowding'. J. Anim. Ecol., 36, 1-30.
- Matsumura, T. 1984. Observations on male hovering activities of Tabanus rufidens (Diptera, Tabanidae). Kontyu, 52, 321-331.
- McClure, R. G. & Stewart, K. W. 1976. Life cycle and predation of the mayfly Choroterpes (Neochoroterpes) mexicans Allen. (Ephemeroptera:Leptophlebiidae). Ann. Ent. Soc. Amer., 69, 134-144.
- Morgan, A. H. 1913. A contribution to the biology of mayflies. Ann. Entomol. Soc. America, 6, 371-413. 13pls.
- Needham, J. G., Traver, J. R. & Hsu, Yin-Chi. 1935. The Biology of Mayflies. New York: Comstock Publ.Co. xiv+759pp.
- Pajunen, V. I. 1966. Aggressive behaviour and territoriality in a population of Calopteryx virgo L. (Odon.,Calopterygidae). Ann. Zool. Fenn., 1, 55-71.
- , 1980. A note on the connexion between swarming and territorial behaviour in insects. Ann. Ent. Fenn., 46, 53-55.
- Parker, G. A. 1970. Sperm competition and its evolutionary consequences in the insects. Biol. Rev., 45, 525-567.
- , 1974. Courtship persistence and female-guarding as male time investment strategies. Behaviour, 48, 157-184.
- , 1978. Evolution of competitive mate searching. A. Rev. Entomol., 23, 173-196.
- Peters, W. L. & Peters, J. G. 1977. Adult life and emergence of

- Dolania americana in Northwestern Florida (Ephemeroptera: Behningiidae). Int. Revue ges. Hydrobiol., 62, 409-438.
- Pritchard, G. 1983. Biology of Tipulidae. A. Rev. Entomol., 28, 1-22.
- Riek, F. E. 1973. The classification of the Ephemeroptera. In: Proceedings of the First International Conference on Ephemeroptera. (Ed. by W. L. Peters & J. G. Peters), pp.160-178. Leiden: E. J. Brill.
- Savolainen, E. 1978. Swarming in Ephemeroptera: the mechanism of swarming and the effects of illumination and weather. Ann. Zool. Fenn., 15, 17-52.
- Spieth, H. T. 1940. Studies on the biology of the Ephemeroptera. II. The nuptial flight. J. N. Y. Ent. Soc., 58, 379-390.
- Takemon, Y. 1985. Emerging behaviour of Ephemera strigata and E. japonica (Ephemeroptera: Ephemeridae). Physiol. Ecol. Japan, 22, 17-36.
- in press. Functional morphology of the genitalia of Epeorus ikanonis (Ephemeroptera: Heptageniidae). Jpn. J. Entomol., 58(1).
- Tanida, K. 1980. Life history and distribution of three species of Hydropsyche (Trichoptera: Hydropsychidae) in the River Kibune (Kyoto, Central Japan), with particular reference to the variations in their life cycle and the relation of larval growth to their density. Jap. J. Limnol., 41, 95-111.
- Tshernova, O. A. 1970. On the classification of the fossil and recent Ephemeroptera. Entomol. Obozr. 44, 124-145. (In Russian with English summary)
- Thew, T. B. 1958. Studies on the mating flight of the Ephemeroptera

- I. The mating flight of Ephoron album (Say) and Stenonema canadense (Walker). Fla. Ent., 41, 9-12.
- Thornhill, R. & Alcock, J. 1983. The Evolution of Insect Mating Systems. Cambridge: Harvard University Press. 547pp.
- Tiensuu, L. 1935. On the Ephemeroptera-fauna of Laatokan Karjala (Karelia Ladogensis). Ann. Ent. Fenn., 1, 3-23.
- Ueda, T. 1979. Plasticity of the reproductive behaviour in a dragonfly, Sympetrum parvulum Barteneff, with reference to the social relationships of males and the density of territories. Res. popul. Ecol., 21, 135-152.
- Waage, J. K. 1984. Sperm competition and the evolution of Odonate mating systems. In: Sperm Competition and Evolution of Animal Mating Systems. (Ed. by R. L. Smith), pp.251-290. Orland: Academic Press, Inc.
- Zalom, F. G. 1979. Notes on male assemblages of Helius flavipes (Macq.) with reference to mating habits (Diptera: Tipulidae). J. Kansas Entomol. Soc., 52, 553-555.

Table I An attendance record of males at each assembly site and swarming site.

	April 1986																			April 1987	
	7	8	9	10	11	12	13	14	15	16	17	18	19	20	21	22	23	24	25	15	16
<b>Assembly</b>																					
A	●	●	●	a	a	●	●	●	a	a	●	●	a	●	-	a	●	●	a	●	●
B	●	●	●	a	a	a	●	●	a	a	●	●	a	●	-	a	●	●	a	●	●
C	●	●	●	a	a	●	●	●	a	a	●	●	a	●	-	a	●	●	●	●	●
D	●	●	●	a	a	a	●	●	a	a	●	●	a	●	-	a	●	a	a	a	a
E	●	●	●	a	a	●	●	●	a	a	●	●	a	●	-	a	●	●	●	●	●
<b>Swarming</b>																					
S1	●	●	●	a	a	●	●	●	a	a	●	●	a	●	-	a	●	●	a	●	●
S2	●	●	●	a	a	●	⊙	⊙	a	a	⊙	⊙	a	●	-	a	●	●	●	⊙	⊙
S3	●	●	●	a	●	⊙	⊙	a	a	⊙	⊙	a	●	-	a	●	●	●	⊙	⊙	

Symbol ● shows presence, a absence, - no data, and ⊙ swarms dispersing over the stream fusing into one continuous swarm.

Table I I Variation of the copula duration in mayflies.

Species	Copula duration	Copulation	Reference
<u>Dolania americana</u>	1-6 sec.	in flight	Peters & Peters (1977)
<u>Ephoron ladogensis</u>	several sec.*	in flight	Tiensuu (1935)
<u>Ephoron albus</u>	several sec.*	in flight	Britt (1962)
<u>Paraleptophlebia debilis</u>	several sec.*	in flight	Lehmkuhl & Anderson (1971)
<u>Choroterpes mexicanus</u>	several sec.*	in flight	McClure & Stewart (1976)
<u>Stenonema canadense</u>	several sec.*	in flight	Thew (1958)
<u>Parameletus chelifera</u>	ca. 20 sec.	on the ground	Brinck (1957)
<u>Baetis</u> sp.	< 30 sec.	in flight	Morgan (1913)
<u>Stenonema vicarium</u>	20-40 sec.	in flight	Cooke (1940)
<u>Isonychia bicolor</u>	25-60 sec.	in flight	Clemens (1917)
<u>Ephemera simulans</u>	< 60 sec.	in flight	Britt (1962)
<u>Epeorus assimilis</u>	90 sec.	in flight	Degrange (1960)
<u>Ecdyonurus</u> sp.	6-7 min.	on the ground	Eaton (1883)
<u>Epeorus ikanonis</u>	1-16 min.**	on the ground	present paper

\* Quantitative data not shown and expressed such as "a few seconds" in original paper.

\*\* n=42,  $\bar{x}$ =6min.05sec., and s.d.=3min.57sec.

## LEGENDS

Figure 1. (a) A map of the study area at Yuyagadani-deai in Kibune Stream. Shaded area with fine and coarse dots shows sandy and pebbly shore, respectively. Shore area without symbols is composed of rock or bush. Shaded area with C shows the shore hung over by bush canopies. Arrows represent rapids and flow directions. (b) Male assembly sites A-E and male swarming sites S1-S3. Rocks are omitted in the figure.

Figure 2. The daily maximum number of males, ovipositing females and mating females of Epeorus ikanonis found in each assembly (A-E).

Figure 3. A flow diagram of the reproductive behaviour of Epeorus ikanonis based on focal female observations in April 1986. A numeral cited at each event represents a total number of observations. Dotted lines show behaviours lacking quantitative data.

Figure 4. Distribution of the sitting males (a), mating pairs (b), and ovipositing females (c) in the male assembly site C on 14 April 1986. Each grid section is 10 X 10 cm in size. The shade of each grid represents the percentage of the daily total counts in the assembly. The cross line in each figure represents the water's edge at normal water level. The upper and lower parts correspond to the water and land area, respectively. Small pebbles and fallen leaves are not drawn in the figure.

Figure 5. Relation of the mean crowding ( $\bar{m}^*$ ) to the mean male density ( $m$ ) (a), and of the  $\bar{m}^*/m$  index to  $m$  (b) for the sitting males of Epeorus ikanonis in the assembly site C. The plot in both figures represents the result of each observation unit (n=22) in the same site C on 14 April 1986.

Figure 6. Relation of copulation density to male density (a), copulation rate of males to male density (b), oviposition density to male density (c) and oviposition density to copulation density (d). Each density indicates the percentage of the total counts in the assembly per 100 cm on 14 April 1986.

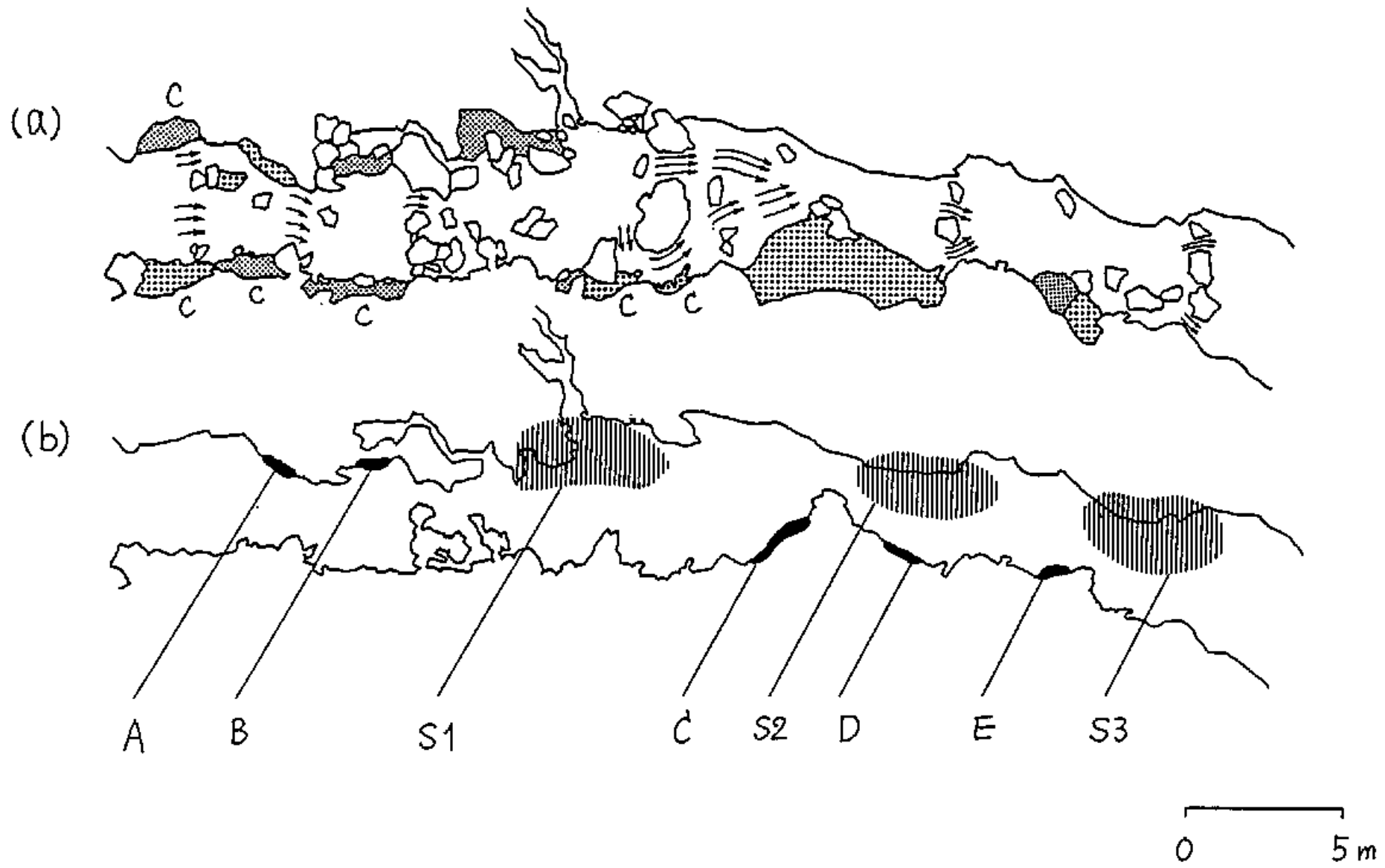

Figure 1. Y TAKEMON

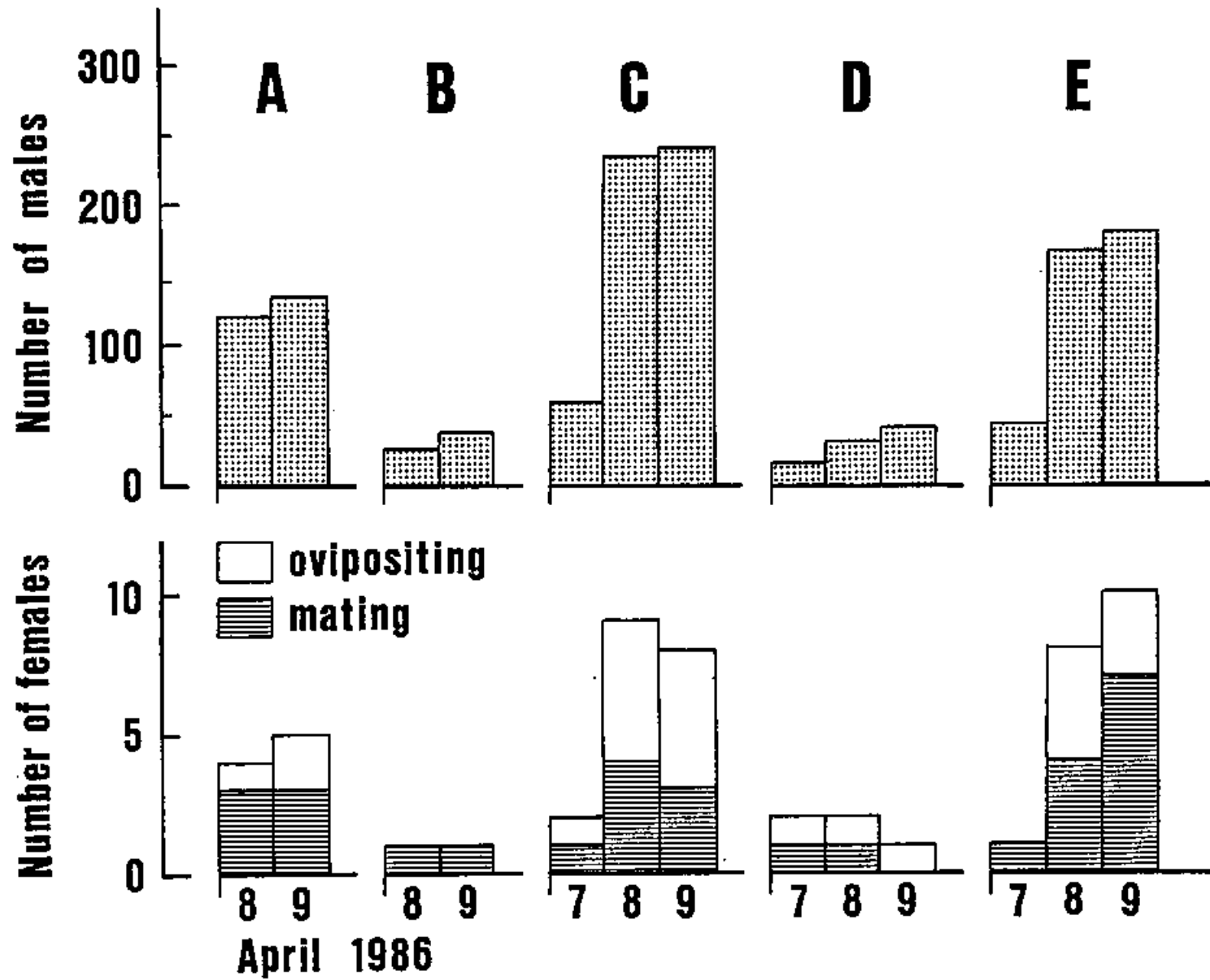

Figure 2. Y. TAKEMDN

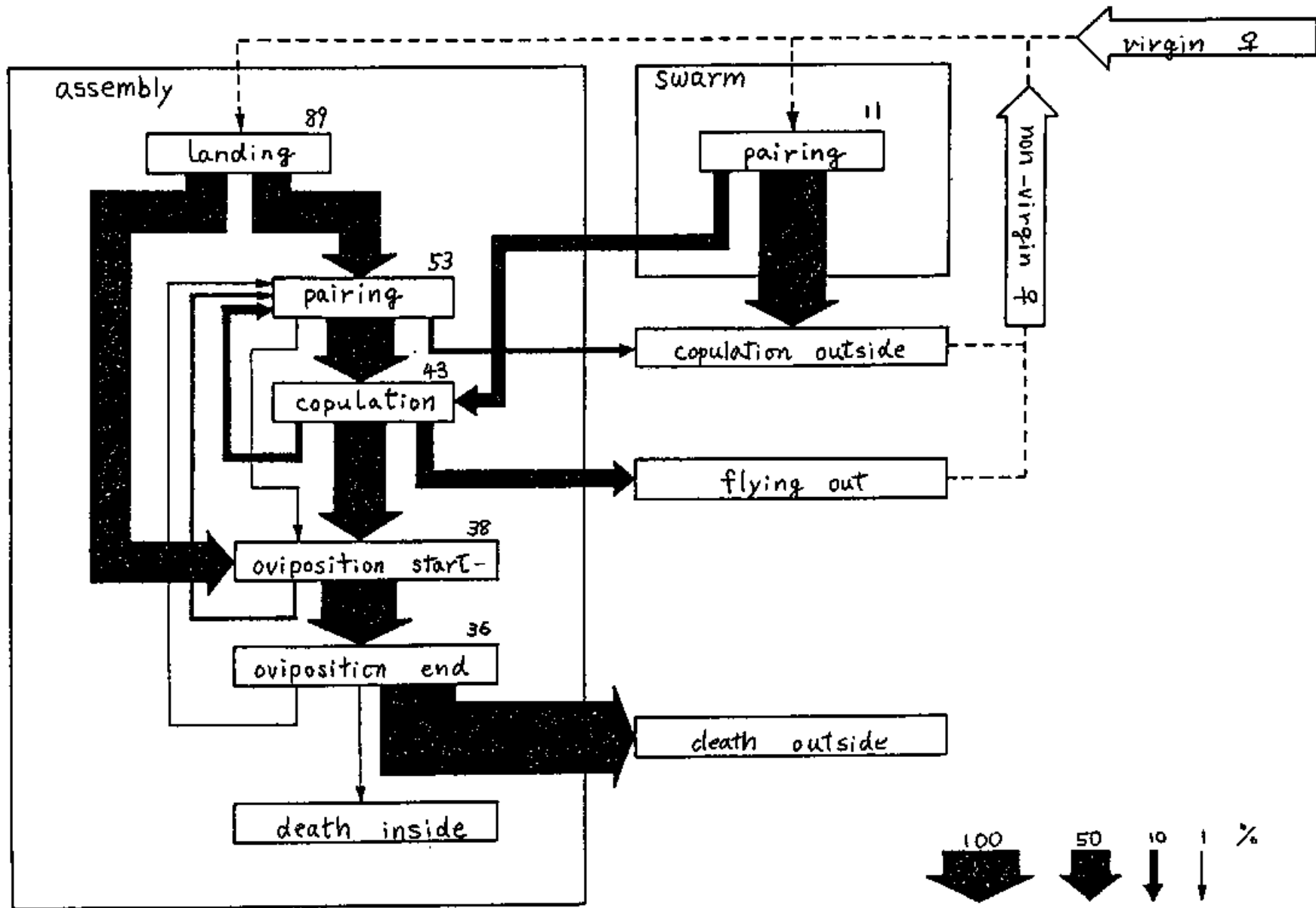

Figure 3. Y TAKEMON

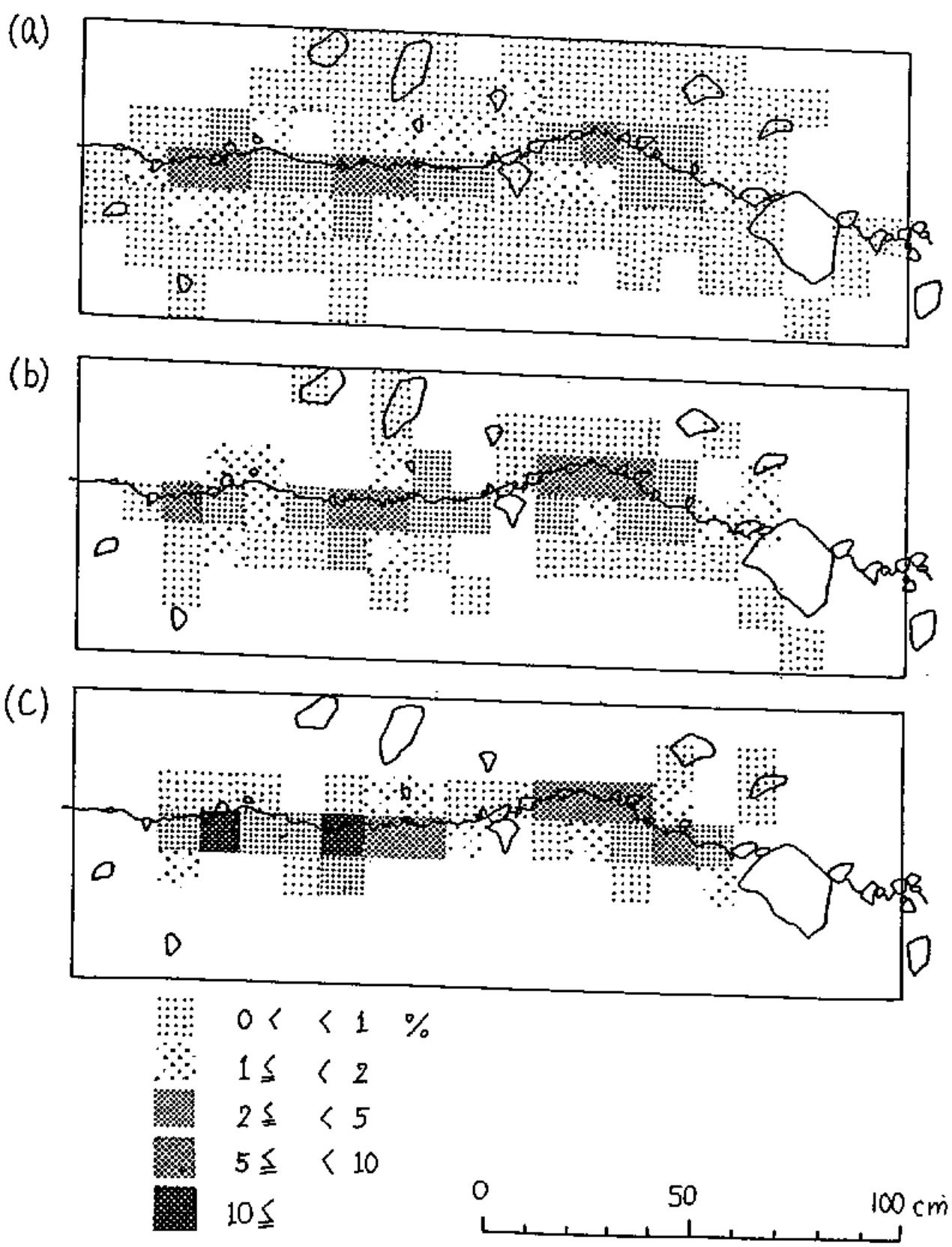

Figure 4. Y. TAKEMON

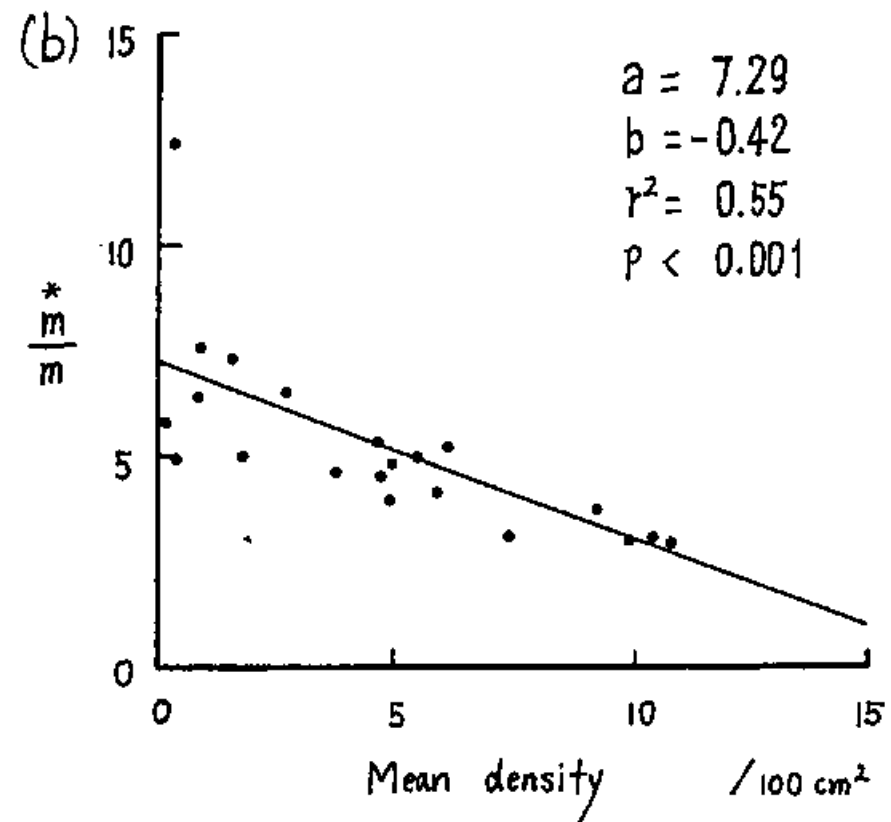
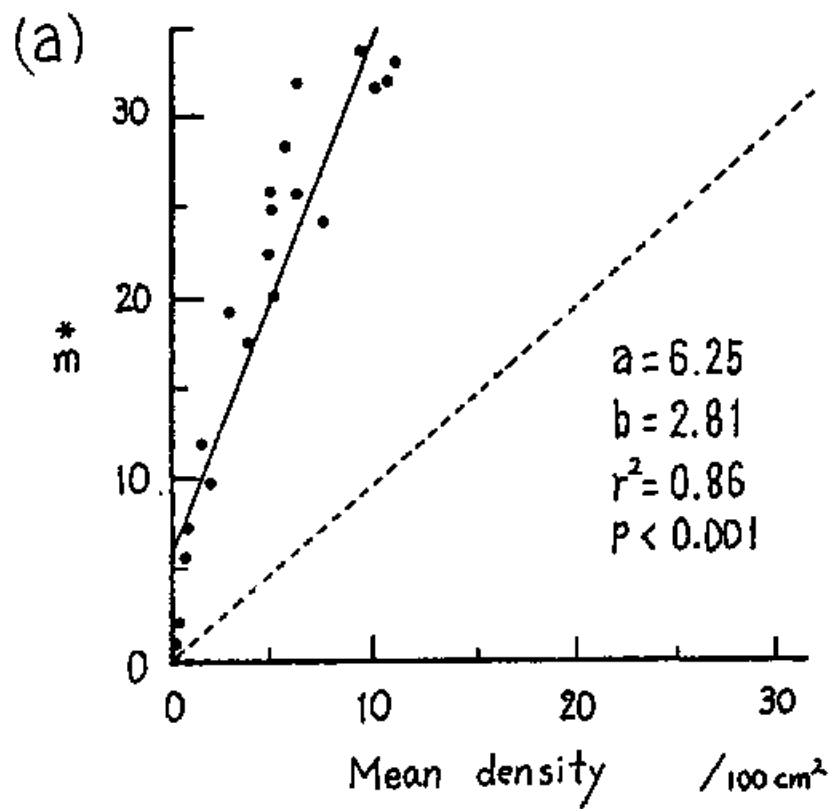

Fig 5

Y. TAKEMORI

Male Assembly in Epeorus ikanonw

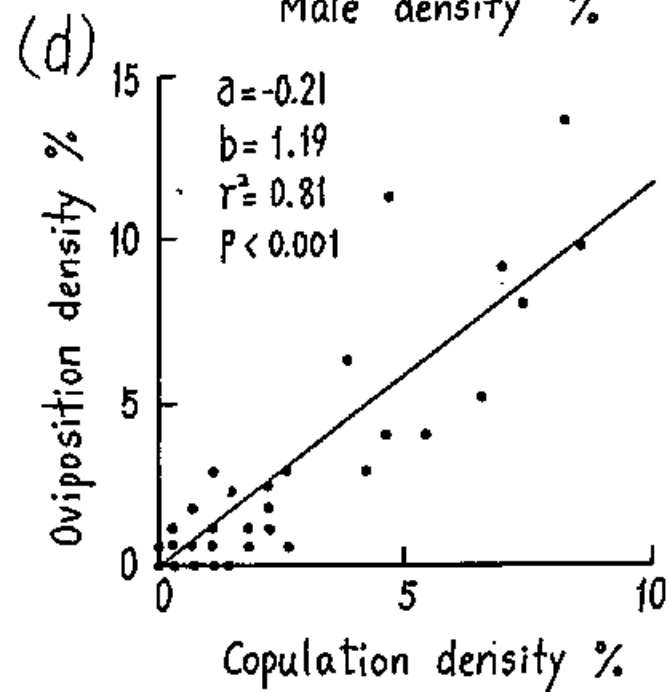
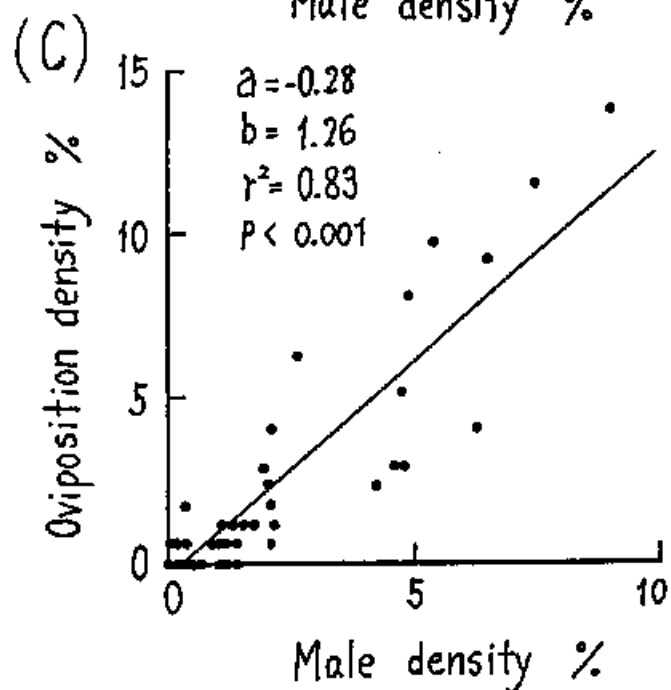
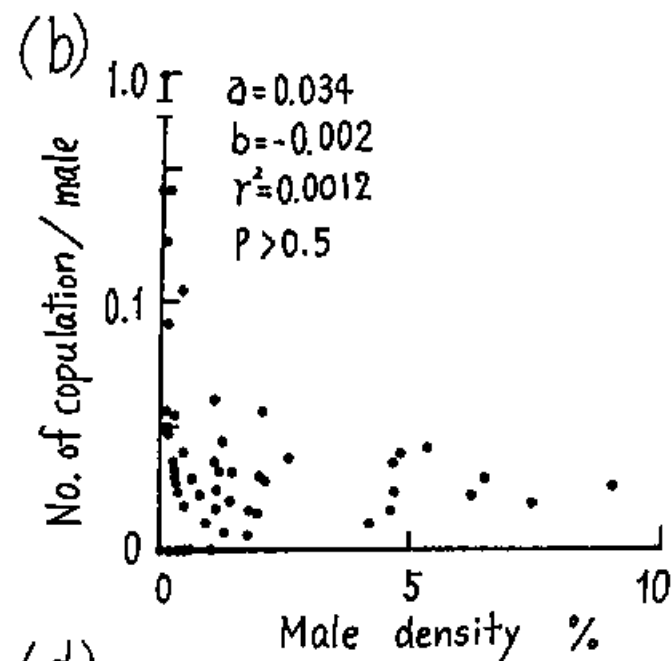
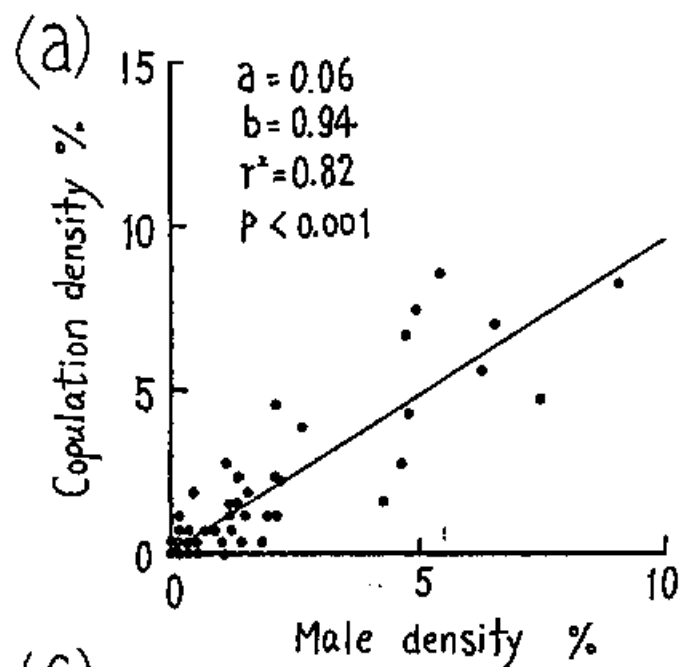

FIGURE 6. Y. TAKEMON

Alternative Male Mating Behaviour of *Epeorus ikanonis*  
(Ephemeroptera: Heptageniidae)\*

Yasuhiro TAKEMON

Department of Zoology, Faculty of Science, Kyoto University,  
Kyoto, 606 JAPAN

\* Contribution from the Laboratory of Animal Ecology,  
Kyoto University, No. XXX.

## ABSTRACT

The males of *Epeorus ikanonis* show assembling behaviour which is regarded as a sit and wait tactic for mating at the oviposition sites, and also show swarming behaviour above the stream and banks. Both alternatives occur at the same time diurnally and seasonally, deriving from the behavioural plasticity within an individual. A sperm precedence ratio balancing the reproductive success of each mate locating behaviour was estimated to be lower than 0.46. The assembling tactic can be explained by sperm competition in case of female multiple copulation and the high predictability of the oviposition sites, whereas the swarming tactic by the gain from mates ovipositing without extra copulation due to the frequent failure of mate recognition by the assembly males and by the gain from a preceding copulation even in the case of female multiple copulations. The protandry found in the emergence timing may be a strategy of males for obtaining the higher reproductive success, which is assured by the physiological longevity of adult males as long as 7.8 days.

## CONTENTS

### INTRODUCTION

### METHODS

Study site and method for observation	6
Sampling of emergent subimagines	6
Estimates of male mating success	7
Estimates of male reproductive success	8
Measurement of body size and sperm remainder in males	10

### RESULTS

Seasonal change of emergence and reproductive activities	10
Diel change of reproductive activities	12
Mating success of each mate locating behaviour	14
Virgin ratio and multiple copulations of females	15
Reproductive success of each mate locating behaviour	16
Body size and sperm remainder of males	18

### DISCUSSION

Ecological correlates of the alternative mating behaviour	19
Balance of male reproductive success	22
Influence of emergence timing and adult longevity	24

### ACKNOWLEDGEMENT

## INTRODUCTION

Males of the heptageniid mayfly *Epeorus ikanonis* Takahashi congregate in large numbers (an assembly) on the stream shore for mate location in addition to the normal swarming in the air in this family (Takemon, part-III). Alternative mate location in mayflies has been reported as the case of two types of swarming behaviour within a species: e.g., males of *Leptophlebia margarita* show two types of swarms at different landmarks (Savolainen, 1978) and males of *Dolania americana* patrol over the stream by a swift horizontal flight and also swarm at landmarks (Peters & Peters, 1977). Although each alternative of above cases may be a different tactic for mate location, neither the proximal mechanisms nor mating success of each alternative has been studied. In this paper, the assembling and swarming behaviour of males of *E.ikanonis* were compared seasonally and diurnally in order to research what kind of proximal mechanisms are probable.

Meanwhile, the average mating success of swarming males has been investigated first on the mayfly *Epeorus longimanus* (Allan & Flecker, 1989). However, the reproductive success as far as mating success has to be considered for investigating the adaptive consequences of alternative mate location behaviour, because females are possible to remate until oviposition and P2 value is probably more than zero at least in *Epeorus ikanonis* (Takemon, 1990).

Although alternative mate location between a swarming tactic and a ground searching tactic has been known also in other insects such as chironomids (Kon et al., 1986), it is generally difficult

to estimate the male reproductive success of a copulation in these species because the full observation of a mate female until oviposition is impossible. In this mayfly, however, the trace of females at the assembly site is rather easy since most of them oviposit there after copulation (Takemon, part-III). Moreover, the oviposition habit of this species, laying all eggs at a time, is advantageous for the estimation of reproductive success of a copulation. Meanwhile, recent studies on the alternative mating behaviour in insects adopt the estimation of the lifetime reproductive success in order to compare the adaptiveness (Arnold & Wade, 1984a ; 1984b; Fincke, 1986; Nishida, 1987). Males of mayflies are disadvantageous in this respect because of their fragileness for marking and of their mass behaviour preventing individual identification. In this paper, therefore, the reproductive success of each alternative was tried to estimate in a sense of that for an average individual engaging in each tactic. The approach of average success may be valid when the adaptiveness of different tactics is to be compared (Dawkins, 1982) and seems to be useful for the animals which exhibit mass-mating behaviour.

For the purpose mentioned above, field observations were conducted on the male mating success, and the multiple copulations and the virgin ratio of females at each mate locating site. The mean reproductive success of each mating behaviour was estimated using a set of assumed values of sperm precedence ratio. The factors influencing the mating and reproductive success of each alternative are discussed in terms of sperm precedence in case of multiple copulations (Takemon, 1990), the seasonal timing of emergence, and the longevity of males (Takemon, part-II).

## METHODS

### Study site and method for observation

The study was conducted at the same area for the previous study (Takemon, part-III). Emergence traps were established at the main station Yuyaga-dani-deai (elevation 360m) and at a supplementary station Jadani-bashi 2.3km downstream from the main station (elevation 230m) along Kibune Stream in Kyoto City.

The sites and number of reproducing individuals were recorded from 7 to 11 April 1986. The mayfly formed assemblies at the sunny shore of a rapid area where gravel or sand accumulated (Takemon, part-III). An assembly site (the site C in Fig.1 in part-III) was partitioned into grid sections 10 X 10 cm in size (see Fig.4 in part-III). The number of males, mating pairs and ovipositing females in each grid were counted from 11 to 25 April 1986.

Swarming males were found at the open space mainly above the stream (Takemon, part-III). The number of swarming males was recorded at a swarming site (the site S in Fig.1 in part-III) at several minute intervals from 11 to 18 April 1986. Mating at the swarming site was recorded by a whole day observation on 18 April 1986. The time investment of males in the swarming flight and the number of females passing the site were observed on 15 and 16 April 1987.

### Sampling of emergent subimagines

Emergent subimagines were collected by using floating-type emergence traps 50 X 60 cm in enclosing area. The sampling at the main station was conducted from 1 April to 23 May 1982 using two

traps, and from 6 April to 25 April 1986 using eight traps. As the subimagines of *E.ikanonis* emerge mostly between 10:00 and 15:00, they were collected after 16:00 every day. The sampling at the supplementary station was conducted from 28 March to 20 April 1985 using three traps.

#### Estimates of male mating success

The mating success of males was represented by the number of copulations per male per minute (per male-minute). The mean mating success of the swarming males (MSS) was given by the total number of copulations divided by the total number of swarming males during the observation on 18 April 1986. The mating success of a swarming male was also measured individually by direct observations on 15 and 16 April 1987.

The number of copulations in the assembly in an unit time  $td$  (CAT) was estimated as follows:

$$CAT = \frac{NC \times td}{CD}$$

NC is the mean number of copulations in  $td$ , CD is the mean copula duration obtained by the direct observation. The mean copula duration were assumed not to change diurnally.

The mean mating success of the assembly males (MSA) was obtained by:

$$MSA = \frac{\sum CAT}{\sum NA \times td}$$

NA is the mean number of assembly males in  $td$ .

### Estimates of male reproductive success

Here, I consider the multiple copulation of females, females laying all eggs at a time, the ratio of virgin females (pv) at the study site, and the sperm precedence value (r). If the value r is constant regardless of the number of previous copulations of the female, the expected male reproductive success for a copulation (S) is swayed by the number of copulations of a mate female after his copulation but not by that before. Here, thus, I consider a male copulating with a female that experiences m times of copulation at the study site and will copulate n times until oviposition after arriving at the study site. The value S in case of (n,m) should be expressed as:

$$\begin{aligned} S(n,1) &= [pv + (1-pv)r] (1-r)^{n-1} \\ &= r(1-r)^{n-1} + pv(1-r)^n \end{aligned} \quad \text{-----(1)}$$

for the first copulation for a mate female at the study site (m=1), and for copulations after the second (m>2):

$$S(n,m) = r(1-r)^{n-m} \quad \text{-----(1)'}$$

Meanwhile, since the values n and m are not able to be determined for all copulations observed, the mean value of S is estimated as follows. At first, the probability of a copulation to be (n,m) is calculated using the data of focal female observation:

$$\frac{1}{n} \times \frac{n \times P_n}{M} = \frac{P_n}{M}$$

$$M = \sum_{i=1}^n i \times P_i$$

Here, P<sub>n</sub> is the ratio of females copulating n times to all

females, and M is the mean number of copulations for females at the study site. Thus  $n \cdot P_n / M$  represents the probability for a male that a mate female belongs to the category of copulating n times after arriving the study site. Note that the  $P_n / M$  is constant irrespective of m.

Accordingly, an expected reproductive success for a copulation (ERC) is shown as:

$$ERC = \sum_{n=1}^{\infty} \left[ \sum_{m=1}^n (S_{n,m} \times \frac{P_n}{M}) \right] = \sum_{n=1}^{\infty} \left[ \frac{P_n}{M} \sum_{m=1}^n S_{n,m} \right] \quad \text{-----}(2)$$

The equation (2) is transformed by substituting (1) and (1)' into:

$$ERC = \frac{r}{M} \sum_{n=1}^{\infty} \left[ P_n \sum_{m=1}^n (1-r)^{n-m} \right] + \sum_{n=1}^{\infty} p_v \times (1-r)^n \times \frac{P_n}{M} \quad \text{-----}(3)$$

The expected reproductive success per male-minute (ERM) was given by multiplying ERC by the mating success. ERC and ERM of each mate-locating behaviour were calculated also using each assumed value of r, which was set at 5% intervals between 0% and 100%.

The value of  $p_v$  was estimated from the hatching success of eggs obtained from the field females. The flying females at the swarming site and the newly landed females at the assembly site were collected on 15 April 1987. The egg rearing experiments were conducted in the laboratory under constant temperature conditions of 10°C and 15°C.

### Measurement of body size and sperm remainder in males

The assembly males (n=36) and the swarming males (n=25) were collected on 16 April 1987. The fore-wing length was measured to the nearest 0.01 mm, which has been known for an indicator well representing the body size in mayflies (Sweeny and Vannote, 1981). Sperm amount in fresh males was measured as a projection area of the sperm reservoir which consists of seminal vesicles, testis and ejaculatory ducts. The regression line between fore-wing length and sperm amount was made using virgin males collected by the emergence traps. Then the amount of sperm consumption in a field male was defined as the balance between an expected sperm amount of a virgin male of its body size and the measured amount.

## RESULTS

### Seasonal change of the emergence and reproductive activities

Subimagines emerged mainly in the first half of April (Fig. 1a and b). The mean emergence date of each sex was 7.2 April 1982 and 5.7 April 1985 for males, and 12.0 April 1982 and 10.1 April 1985 for females, and thus males emerged earlier (4.8 days earlier in 1982 and 4.4 days in 1985) than females. The mean emergence date in 1986 was unknown because of lack of data on the first emergence. The emergence at the supplementary station in the lower stream was shifted earlier by a few days (1.6 days in male and 1.9 days in female on average) than that in the main station.

The emergence of subimagines was rather dispersed seasonally

but was comparatively abundant from 5 to 15 April. The influence of weather and temperature conditions on the numbers emerging was indistinct (Fig.1b and c): rainy weather and low temperature conditions on 10, 11, 15 and 19 April did not reduce the emergence. The only exception is that no emergence occurred on 16 April when the atmospheric temperature was below 8 °C.

The duration of the subimaginal stage was longer than 19 hours and shorter than 30 hours under constant temperature conditions of 16°C ±1°C in the laboratory. The duration in the field was 7.2 days on the average (Range: 4-9, N=55) for males and 6.5 days (Range: 4-8, N=34) for females, which was determined by the field experiment in 1988 (Takemon, unpublished; see also Takemon, part II).

The number of adults engaged in reproduction showed distinct peaks on 13, 14 and 17 April and moderate peaks on 7, 8, 9, 18 and 23 April in spite of the comparatively dispersed emergence of subimagines (Fig.1b and c). Neither sex showed any reproductive activities on rainy days whatever the temperature conditions. On cloudy days, their activities were hindered by low temperatures such as on 16 April. Thus the reproduction of this species was restricted to either fine or warm, cloudy days. The daily maximum number of males in an assembly and a swarm fluctuated seasonally in a similar manner.

The number of assembly males decreased linearly from 17 to 25 April, 1986 (Fig.1b). As the male emergence ceased after 18 April, the number of males in this period reflects their longevity. The mean survival rate and longevity of adult males in the field after 17 April was estimated to be 0.47 per day and 2.13

days, respectively, by the Richards-Waloff method (Ito & Murai,1977), assuming that the mortality rate was constant among individuals through the period and that the percentage presence of males at the assembly was not changed. As the adult longevity of mayflies is inversely correlated to atmospheric temperatures (Brittain,1982; Ward & Stanford,1982), the mean longevity of adult males before 17 April should be longer than 2.13 days. Therefore it was roughly estimated that an average male could have attended the assembly for at least three days after moulting.

#### Diel change of the reproductive activities

The assembly males appeared in the late morning, increased in number for a few hours, peaked and decreased in number in the afternoon and disappeared before dusk (Fig.2a). The start and end of the assembly shifted seasonally. A slight decrease occurred in the mid-afternoon on 14 and 17 April. These activity patterns of the assembly males were explained well by the relation to atmospheric temperatures (Fig.3a). The number of males increased when the temperature exceeded 10 °C, decreased at temperatures lower than 11 °C and disappeared below 10 °C. The slight decrease in the mid-afternoon corresponded to the temperature exceeding 14 °C. Most of the assembly males did not take off unless they were disturbed. Thus the mean time investment of a male in assembling behaviour was estimated as the total male-minutes divided by the daily maximum number of males: i.e., 105', 189', 232', and 228' on 9, 13, 14, and 17 April, respectively. Note that replacement of individuals was assumed not to have occurred in this estimation.

Diel changes in the number of copulations and ovipositions were

similar except that the oviposition started earlier and ceased later (Fig.2a). Ovipositions preceded copulations on 14 and 17 April, which indicates that some females had copulated out of the assembly in the morning or had copulated in the previous day. The relation to the atmospheric temperature was rather irregular, particularly at the point of initiation. Both activities reached their daily maxima over a range of temperatures between 11 °C and 14 °C, and decreased below 11 °C (Fig.3b and c).

Swarming started about 30 minutes earlier and disappeared earlier than assembly (Fig.2b). The maximum number of swarming males was recorded earlier than that of assembly males. The number of swarming males increased slightly when the assembly males decreased in the mid-afternoon on 14 and 17 April. Many of the assembly males were observed to join the swarm just after take-off in this time period. Swarming males increased in number again before the end of daily activities. Copulations by swarming males tended to occur more frequently in the earlier half of the diel activities (Fig.2b). The number of females flying across the swarming site was also more in the earlier period (Fig.2c).

The mean time investment of a male in swarming flight was estimated as only 10'45" (Table 1). A part of them landed on the assembly sites after swarming, which shows that both males behaviours could be conducted within a day by a same individual. Males landing on the assembly sites or changing the swarm site spent a longer time for the swarming flight than those returning to the resting sites ( $P < 0.001$ ). Landing males were more frequent in the earlier part of diel activities. The daily total number of swarming males at the swarming site was estimated as the total

male-minutes divided by the mean time investment in swarming behaviour: i.e., 168, 415, 617, 356, and 322 males on 9, 13, 14, 17, and 18 April, respectively.

The relative abundance of swarming males (the daily total number of swarming males divided by the daily maximum number of assembly males) show non of significant seasonal change (Fig.4). It shows that there is no trend in the seasonal shift of mate locating behaviour in this species. Since the number of males was counted at a site for each behaviour in this study, the relative abundance not always reflected the total value of the population. But the seasonal trend of the population should be reflected since the relative abundance among sites was rather stable seasonally (Takemon, part-III).

#### Mating success of each mate locating behaviour

The mean mating success of the swarming males (MSS) shown in Table 2 indicates that a swarming male had a probability of mating once per 6.92 hours. Considering the time investment in the swarming flight (Table 1), most males seemed to have given up without gain. Pairing in a swarm was also rare in the preliminary observations in 1982 and 1985.

The mean mating success of assembly males in each observation unit (CAT) is shown in Fig.5. The value CAT decreased when the number of assembly males reached the daily peak, except on 17 April when the daily peak in the number of females coincided with that of the assembly males. Thus the high values of CAT were obtained near the start or the end of the daily activity.

Results of the daily mean mating frequency of the assembly

males (MSA) (Table 3) indicate that an assembly male had a chance of mating once per 7.31 hours at least, once per 2.24 hours at most and once per 3.24 hours on average. Considering the time investment of males in assembling behaviour, an average male in the assembly was able to copulate more than once on 13 and 17 April, about once on 14 April and less than once on 9 April.

#### Virgin ratio and multiple copulations of females

Though the virgin ratio of the flying females at the swarming site was higher than the landing females at the assembly site, the difference was not significant (Table 4). The result showed that virgin females also land on the assembly site.

Sequential copulations of a female with swarming males were not observed (n=10). Thus females was assumed to land on the assembly site after copulation with swarming males.

In contrast, at the assembly site, females copulating twice with another male comprised 11.2% of all females which copulated (Table 5). Though triple copulations were found, the frequency was very low. In spite of the non-virgin ratio of landing females as high as 82.4%, only 51.7% of them laid eggs without copulation at the assembly site (See Fig.3 in Takemon, part III). Thus 30.7% of the landed females were estimated to have copulated at least twice by the first copulation at the assembly site. Therefore 62.8% of non-virgin females are assumed to oviposit and 37.2% of them to copulate at the assembly site.

### Reproductive success of each mate locating behaviour

The probability of n times copulation of a mated female (Pn) was calculated according to the following model of mating behaviour (See also Fig.3 in Takemon, part III) : i.e. females after copulation with swarming males land on the assembly site, 37.2% of non-virgin females copulate with assembly males after landing, the probability of the number of copulations at the assembly site is given in Table 5, 23.3% of females take off after copulation at the assembly site and they land again after passing a swarm. Females after the secondary landing are assumed not to take off again until completing oviposition. The process of calculation of Pn and values obtained are shown in Tables 6 and 7, for a mate of assembly males and for that of swarming males, respectively.

The expected male reproductive success per copulation (ERC) for assembly males was calculated by substituting pv in Table 4 and Pn in Table 6 into the equation (3) (in the Methods), and by deducting the success of swarming males gained by copulation with taking off females from the assembly site. The process for getting the latter value is shown in Table 8.

The calculation of ERC for swarming males was divided into two processes. First, when the mate had never landed on the assembly site, the copulation was the first one of n times copulation for the mate. Thus the ERC for swarming males in this case (ERC1) is:

$$ERC1 = \sum_{n=1}^8 Pn' \times Sn,1 \quad \text{-----(4)}$$

Second, when the mate had come from the assembly site, the value

of ERC was calculated in the same way as Table 8, using  $P_n'$  and  $M'$  (Table 7) instead of  $P_{n-1}$  and  $M$ , respectively (ERC2). Consequently, the ERC for a swarming male was given by the total of ERC1 and ERC2.

The relation of ERC to  $r$  for each mate locating behaviour is illustrated in Fig.6a. The ERC of assembly males changed from 0.14 to 0.81, according to  $r$ , whereas that of of swarming males changed only from 0.33 to 0.63. The ERC became equal between them when  $r$  was 0.54, which means that the gain from a female balanced at this  $r$  in a mean sense. However, as the copulation frequency was higher in the assembly than in the swarm, the ERM of assembly males was always higher except when  $r$  was less than 0.02 (Fig.6b). This result indicates that assembly males have a higher reproductive success than swarming males when a succeeding copulation can fertilize more than 2% of all the eggs.

The above estimations were based on the virgin ratio obtained by the limited observation. Thus a possible range of ERM was calculated using a set of assumed values of the virgin ratio ( $p_v$ ). The virgin ratio at the assembly site was set at 0.05 intervals between 0.000 and 0.483. The value 0.483 corresponds to the probability of copulation by a landing female. The value for  $p_v$  at the swarming site was assumed to be between that of landing females and 1.00. The value of  $P_n$  was calculated for each assumed value of  $p_v$  in the same way as in Tables 6 and 7 (Appendix 1 and 2). The relation of ERM to  $r$  is shown in Fig.7a and b for the assembly and swarming males, respectively. Then a range of  $r$  balancing ERM of each mate-locating behaviour was determined by the crossing area of the line for assembly males and the area for

swarming males as shown in Fig.8a. Consequently, even in a case of extreme  $p_v$  (0.00 for landing females and 1.00 for flying females), each mate-locating behaviour balanced in success only when  $r$  was lower than 0.46, 0.40 or 0.32 corresponding to the minimum, the mean, or the maximum estimate of the copulation frequency of assembly males, respectively (Fig.8b).

#### Body size and sperm remainder of males

There was no significant difference in the fore wing length between assembly males and swarming males ( $P > 0.05$ , t-test) (Fig.10 c and d). Thus the alternative mate location was not size-dependent. If size-dependence operates, the relative abundance of each alternative would have changed seasonally, since seasonal size reduction of the emergent adult was detected both in the fore wing length and in the sperm amount (Fig.9).

The sperm amount of virgin males correlated to the fore wing length (Fig.10 a and b). The mean sperm remainder of swarming males was significantly more than that of assembly males ( $P < 0.001$ ), though the range of variation (20-100%) did not differ between the alternatives (Fig.10 c and d).

## DISCUSSION

Takemon (part III) described that adult males of the mayfly *Epeorus ikanonis* locate their mates in two ways: i.e., the assembling behaviour on the ground which is regarded as a sit-and-wait tactic at the oviposition sites and the swarming behaviour

above the stream and banks. He mentioned that the former tactic evolved through following reasons: the multiple copulation of females, the P2 value more than zero, the concentrated distribution of oviposition sites, and the mate recognition method through body contact. However, reasons for the swarming behaviour as an alternative tactic have never been discussed. Herein, the ecological correlates of the alternatives and the balance of male reproductive success between them are discussed.

#### Ecological Correlates of Alternative Mating Behaviour

Many of the assembly males were observed to join the swarm just after take off in the mid-afternoon on 14 and 17 April, when the number of assembly males decreased slightly. Thus the increase of swarming males before the end of daily activities may be derived also from the assembly males. The time investment of males in swarming flight was as short as 10'45" on average and a part of them was observed to land on the assembly sites. All these facts indicate that males conduct both swarming and assembly behaviour within a day and the alternative is caused by the behavioural plasticity within individuals (Cade, 1980; Dawkins, 1980). As conditional factors corresponding to the shift in the behaviour, following possibilities have been known: i.e., individual conditions such as the body size, physical environmental conditions, and densities of individuals (Thornhill & Alcock, 1983; Fincke, 1985).

Alternation of mating behaviour can occur with seasonal changes (Fincke, 1985; Hayashi, 1985). But each alternative of this species was not segregated seasonally. Thus, the environmental factors

associated with a season must be uncritical for the conditional factors.

Diel timing is one of the important factors for alternation of mate locating behaviour in insects (Scott,1974; Fincke,1985; Kaiser,1985). In this species, the diel change of the male abundance was slightly different between the assembly and the swarm, nevertheless the hourly overlap of the two. The swarming males appeared and peaked earlier than the assembly males. As the swarming males landed on the assembly sites more frequently earlier in the day, they seem to have attended to the swarm on the way to the assembly sites. While, the number of swarming males also increased slightly according to the decrease of the assembly males, indicating that the males joined the swarm again on the way to the resting sites. The reason for the less increase may be the shorter time investment to the swarming behaviour in this case. Since the number of assembly males was regulated strictly by the atmospheric temperature, the peak timing in the number of swarming males coincides with the lower and higher temperature limits for the assembling behaviour. Therefore, it is probable that males apt to swarm at the lower and the higher temperature limit for the assembling behaviour. It may be concluded that the males attend swarms on the way to the assembly sites and sometimes on the way to the resting sites, and which timing is mainly affected by temperature conditions.

Are there any adaptive reasons for this diel pattern ? The distribution of receptive females has been considered as the factor affecting alternative mating behaviours (Parker,1978), and it has been empirically supported also in odonates (Ueda,1985,

Fincke,1985). In this species, the number of females passing the swarming site was more in the earlier half of the diel activities. On the other hand, the number of copulations and ovipositions at the assembly site increased comparatively in the later period. Thus the earlier peak of the swarming males and the later one of assembly males may correspond to the abundance of females at each site. Then, why did males of each behavioural type keep appearing overlapping through diel activities ? The mean mating success of the assembly males (CAT) highly fluctuated within a day. Its peak not always corresponded to that of the number of assembly males because the female arrival was not restricted to a particular period. As a result, CAT became high values in an unpredictable manner within a day. It means that minor males who stay at the assembly site earlier or later than major individuals might be given the chance of mating. The same thing may occur for swarming males and the diel timing of each behaviour seems to be prolonged overlapping each other.

Size dependence has been considered as an individual condition sometimes (Rubenstein,1984; Hayashi,1985). Allan & Flecker (1989) reported the higher mating success of larger males in a swarm of the congeneric mayfly *Epeorus longimanus*. And thus, the size dependence as a conditional factor may be possible in mayflies. In fact, however, the fore wing length was not different between swarming males and assembly males in the current species. Meanwhile, the sperm remainder in males may relate to the alternative since swarming males had significantly more sperm than assembly males. It is probable that virgin males apt to attend the swarm more frequently or stay there longer than experienced males.

But further investigation is required for certification. Although it is also probable that the sperm remainder reflects age since mayflies do not produce additional sperm in the adult stage (Takemon, 1990), this possibility is negative considering the lack of seasonal change of the relative abundance in the alternatives.

Many examples of alternative mating behaviour in insects belong to a conditional strategy depending on male density: e.g., in odonates (Higashi, 1969; Ubukata, 1975; Ueda, 1979; Alcock, 1982; Tsubaki & Ono, 1986), chironomids (Kon et al., 1986), and gerrids (Hayashi, 1985). Kon, et al. (1986) showed that the relative abundance of each behaviour is controlled by the density of adults for the chironomid *Tokunagayusurika akamushi* :i.e., the searching tactic on the ground is advantageous under higher densities whereas the swarming tactic is under lower densities. In these cases, the alternatives are maintained in a population since the reproductive success of one tactic exceeds the other under different densities. In case of *E.ikanonis*, however, density dependence could be detected neither in seasonal nor diel changes.

The lack of density dependence is attributed to the ideal free distribution of the mating frequency at the assembly site (Takemon, part-III). As each male is almost even in mating chance irrespective of the male density in the assembly, the density itself can not function as a cue for changing behaviours.

#### Balance of male reproductive success

The mean reproductive success (ERM) of each alternative is balanced when the sperm precedence ratio ( $r$ ) or P2 value is below 0.46 at most and 0.32 at least, corresponding to the minimum and

maximum estimate of the mating success of assembly males, respectively. As this estimation covers sampling errors for determining the virgin ratio (pv) by assuming the range of values including the unlikely extreme case, it should reflect the correct value in the field as far as the copulation frequency of the swarming males is an adequate value. Although P2 value has never been measured, Takemon (1990) estimated it to be rather low values based on morphological evidences on the sperm utilization. Therefore, the possibility of unbalance of reproductive success derived from high P2 values may be negative.

The alternatives might be maintained in the population without balance of reproductive success. If any ecological factors such as predation or food resource are one sided, the reproductive success will be unbalanced. Since mayflies do not take food in the adult stage, the factor of feeding can be neglected. As to predation, only a few individuals were occasionally taken by the dungfly *Scatophaga stercoraria* and by the wagtail *Motacilla cinerea* during reproduction in this species (Takemon, unpublished). The dungflies ate sitting individuals but they are very few in number, whereas the wagtails ate a lot of mayflies but they caught emerging subimagines selectively and were rather nonchalant with both sitting and swarming adults. The low predation on this mayfly, particularly on the assembly males may be related to the emergence season in the early spring. Although the hunter spiders such as *Dolomedes raptor* are very abundant in the study area from May to September, they are non-active in March and April (Takemon, unpublished.) Since swarming mayflies in the air have been presumed to be less vulnerable to predation than resting

individuals (Edmunds & Edmunds,1980), less predation pressure in this season may facilitate the mate location behaviour by sit-and-wait tactic. However, this factor is not persuasive for the swarming behaviour remaining in the population.

Extreme cases of unbalance of reproductive success may be the males of some dipteran species forming swarms nevertheless copulations are always initiated on substrates (Syryamaki,1964; 1976; Oliver,1968; Nielsen & Greve,1950; Nielsen & Haeger,1960). Syryamaki (1964; 1976) interpreted swarms of this type as or a behavioural relic. In this mayfly, however, the swarming behaviour is not able to be called relic since the copulation occurs in the swarm even low in frequency and the male reproductive success is also expected. Supposing the number of swarming males decreased in the population, the opportunity of copulation per male will increase since the male can occupy a swarming space with less competition. The fact that the range of a swarm dispersed not only above stream but also above banks under high density conditions (Takemon,part-III) indicates the existence of male-male competition. Therefore the swarming habit would not disappear even if it's proportion decreased. Consequently, the balance of the reproductive success between the alternatives seems to be more probable.

The method of mate recognition of the assembly males may play an important role for increasing the success of swarming males (Takemon,part-III). The high percentage of females ovipositing without copulation at the assembly site (51.7%) resulting from the mate recognition method seems to function as a factor increasing the reproductive success of the swarming tactic.

In consequence, a reproductive success for the swarming tactic as high as that of the assembly tactic seems to be assured by mainly two factors: 1) the high percentage of females ovipositing without copulation at the assembly, and probably 2) low P2 values allowing a chance of fertilization for the preceding copulation even if it is reduced by successive copulations.

#### Influence of emergence timing and adult longevity

How does the seasonal timing of emergence influence the reproductive success in *E.ikanonis*? Many of aquatic insects have been known for their seasonally synchronous emergence particularly among species emerge in spring seasons (Macan,1958; Sweeny and Vannote,1981; Takemon,1985: 1990a). Some workers have remarked that the short emergence period of aquatic insects increases the probability of encounter with the other sex and hence the chance of reproduction (Macan,1958; Downes,1969; Tjonneland,1970; Gibbs,1977; Savolainen,1978; Nomakuchi & Higashi,1988). However, it has never been proved how the seasonal timing of emergence is critical to the mating success.

Dates of fruitful reproduction of this species are limited to only a few days in a reproductive season and their timing is determined by the weather conditions which change with irregular cycles in this season. Therefore, it is required for males to emerge earlier than the most fruitful days including the subimaginal period of 7.2 days on average. Since the fruitful days were 14 and 17 April in case of 1986 judging from the daily mean mating success of assembly males, the males emerged earlier than 6 April should have been more advantageous than those emerged later.

In this respect, the longevity in the adult stage seems to be very important for the male reproductive success, since the most fruitful days are unpredictable for them and the males emerged earlier periods should wait until the opportune time. Takemon (part-II) revealed that the adult males of this species has the physiological longevity as long as 7.8 days on average and the maximum of 16 days. Although the longevity of the field males may be shorter, it was estimated to be longer than 3 days in this study. The difference of the mean emergence date between sexes, 4-5 days earlier in males, may be a male reproductive strategy for setting adult stage on the most fruitful days.

#### ACKNOWLEDGMENT

I wish to thank Prof. Hiroya Kawanabe and Dr. Takuya Abe, Dept. Zoology, Kyoto University, Prof. David L.G. Noakes, Dept. Zoology, University of Guelph, Dr. Kazumi Tanida, Dept. Life Sciences, University of Osaka Prefecture, Dr. Takayoshi Nishida, Dept. Agriculture, Kyoto University, and Tetsuyuki Ueda, Laboratory of Natural Sciences, Ishikawa Agricultural College, for their critical reading of the draft of this paper, Mr. Torii for kindly allowing use of his property for the field work, Ms. Naobi Okayasu, Dept. Zoology, Kyoto University, for help with sampling, and other members of the Laboratory of Animal Ecology in Kyoto University for their comments on the current work. This study is partially supported by the Grand-in-Aid of Scientific Research (Nos. 57480006 and 61480005), for Cooperative Research (No.

62304003) and for Special Project Research on Biological Aspect of Optimal Strategy and Social Structure (Nos. 58121004, 59115504 and 6107092) from Japan Ministry of Education, Science and Culture.

#### REFERENCES

- Alcock, J. 1982. Post-copulatory male guarding by males of the damselfly *Hetaerina vulnerata* Selys (Odonata: Calopterygidae). *Anim. Behav.* 30:99-107.
- Arnold, S.D. and Wade, M.J. 1984a. On the measurement of natural selection and sexual selection: Theory. *Evolution* 38:709-719.
- Allan, J.D. & Flecker, A.S. 1989. The mating biology of a mass-swarming mayfly. *Anim. Behav.* 37:361-371.
- Arnold, S.D. and Wade, M.J. 1984b. On the measurement of natural selection and sexual selection: Application. *Evolution* 38:720-734.
- Cade, W. 1980. Alternative male reproductive behaviour. *Fla. Entomol.* 63:30-45.
- Dawkins, R. 1980. Good strategy or evolutionarily stable strategy? In: Barlow, G.W. & Silverberg, J. eds. *Sociobiology: beyond nature/nurture?* pp.331-367. Westview Press. Colorado
- . 1982. *The Extended Phenotype. The Gene as the Unit of Selection.*
- Downes, J.A. 1969. The swarming and mating flight of Diptera. *Ann. Rev. Entomol.* 14:271-298.
- Edmunds, G.F. Jr. & Edmunds, C.H. 1980. Predation, climate, and

- emergence and mating in mayflies. In: Flannagan, J. & Minshall, K. (ed.). *Advances in Ephemeroptera Biology*. Plenum Press. New York. pp.275-288.
- Ehrlich, P.R. & Wheye, D. 1986. "Nonadaptive" hiltoping behaviour in male checkerspot butterflies (*Euphydryas editha*). *Am. Nat.* 127:447-483.
- Fincke, O.M. 1985. Alternative mate-finding tactics in a non-territorial damselfly (Odonata:Coenagrionidae). *Anim. Behav.* 33:1124-1137.
- , 1986. Lifetime reproductive success and the opportunity for selection in a nonterritorial damselfly (Odonata:Coenagrionidae). *Evolution* 40:791-803.
- Gibbs, K.E. 1977. Evidence for obligatory parthenogenesis and its possible effect on the emergence period of *Cloeon triangulifer*. *Can. Entomol.* 109:337-340.
- Hayashi, K. 1985. Alternative mating strategies in the water strider *Gerris elongatus* (Heteroptera, Gerridae). *Behav. Ecol. Sociobiol.* 16:301-306.
- Higashi, K. 1969. Territoriality and dispersal in the population of dragonfly, *Crocothermis servilia* Drury (Odonata:Anisoptera). *Mem. Fac. Sci. Kyushu Univ. (Biol.)* 5: 95-113.
- Ito, Y. & Murai, M. 1977. *The Research Method of Animal Ecology*. The first volume. Kokin Shoin, Tokyo. 268pp. (In Japanese)
- Kaiser, H. 1985. Availability of receptive females at the mating place and chances of males in the dragonfly *Aeschna cyanea*. *Behav. Ecol. Sociobiol.* 18:1-7.
- Kon, M., Otsuka, K. & Hidaka, T. 1986. Mating system of *Tokunaga-yusurika akamushi* (Diptera:Chironomidae): I. Copulation in

- the air by swarming and on the ground by Searching. *J. Ethol.* 4:49-58.
- Macan, T.T. 1958. Causes and effects of short emergence periods in insects. *Verh. Int. Ver. Limnol.* 13:845-849.
- Matsumura, T. 1984. Observations on male hovering activities of *Tabanus rufidens* (Diptera, Tabanidae). *Kontyu* 52:321-331.
- Nishida, T. 1987. Measurement of the opportunity for natural and sexual selection in a breeding population of the coreid bug (*Colpula lativentris*). *Res. Popul. Ecol.* 29:271-289.
- Nielsen, E.T. & Greve, H. 1950. Studies on the swarming habits of mosquitoes and other Nematocera. *Bull. Ent. Res.* 49:305-313.
- Nielsen, E.T. & Haeger, J.S. 1960. Swarming and mating in mosquitoes. *Misc. Publ. Entomol. Soc. America* 1:71-95.
- Nomakuchi, S. & Higashi, K. 1988. Synchronization of reproductive period among the two male forms and female of the damselfly *Mnais pruinosa* Selys (Zygoptera: Calopterygidae). *Ecol. Res.* 3:75-87.
- Oliver, D.R. 1968. Adaptations of arctic Chironomidae. *Ann. Zool. Fenn.* 5:111-118.
- Parker, G.A. 1978. The evolution of competitive mate-searching. *Ann. Rev. Entomol.* 23:173-196.
- Peters, W.L. & Peters, J.G. 1977. Adult life and emergence of *Dolania americana* in Northwestern Florida (Ephemeroptera: Behningiidae). *Int. Revue ges. Hydrobiol.* 62:409-438.
- Rubenstein, D.I. 1984. Resource acquisition and alternative mating strategies in water striders. *Am. Zool.* 24:345-353.
- Reisen, W.K., Knop, N.F. & Peloquin, J.J. 1985. Swarming and mating

- behavior of laboratory and field strains of *Culex tarsalis* (Diptera: Culicidae). *Ann. Ent. Soc. Amer.* 78:667-673.
- Savolainen, E. 1978. Swarming in Ephemeroptera: the mechanism of swarming and the effects of illumination and weather. *Ann. Zool. Fennici* 15:17-52.
- Scott, J.A. 1974. The interaction of behavior, population biology, and environment in *Hypaurotis crysalus* (Lepidoptera). *Am. Midl. Natur.* 91:383-394.
- Sweeny & Vannote. 1981. *Ephemerella* mayflies of White Cley Creek: bioenergetic and ecological relationships among six coexisting species. *Ecology* 62:1353-1369.
- Syrjamäki, J. 1964. Swarming and mating behaviour of *Allochironomus crassiforceps* Kieff. (Dipt., Chironomidae). *Ann. Zool. Fennici* 1:125-145.
- . 1976. The mystery of the missing females in connexion with male swarming of Blacus ruficornis Nees (Hym., Braconidae). *Ann. Ent. Fenn.* 42:66-68.
- Takemon, Y. 1985. Emerging behaviour of *Ephemera strigata* and *E. japonica* (Ephemeroptera: Ephemeridae). *Physiol. Ecol. Japan* 22:17-36.
- . 1990a. Timing and synchronicity of the emergence of *Ephemera strigata*. In: Campbell, I. (ed.) *Mayflies and Stoneflies: biology and life histories*. Junk. (In press.)
- . 1990b. Functional morphology of the genitalia of *Epeorus ikanonis* (Ephemeroptera: Heptageniidae). *Jpn. J. Entomol.* 58 (1). (In press)
- . part-II. Water intake by adult males of mayflies and its effect on their longevity. (Unpublished)

- . part-III. Male assembly on the ground for mate location in the mayfly *Epeorus ikanonis* (Ephemeroptera:Heptageniidae). (Unpublished)
- Thornhill, R. & Alcock, J. 1983. *The evolution of insect mating systems*. Harvard Univ. Press Cambridge 547pp.
- Tjonneland, A. 1970. A possible effect of obligatory parthenogenesis on the flight activity of some tropical larvo-aquatic insects. *Arbok. Univ. Bergen Mit-Naturvittensk Ser.* 3: 1-7.
- Tsubaki, Y. & Ono, T. 1986. Competition for territorial sites and alternative mating tactics in the dragonfly, *Nannophya pygmaea* Rambur (Odonata:Libellulidae). *Behaviour* 97:234-252.
- Ubukata, H. 1975. Life history and behavior of a corduliid dragonfly, *Cordulia aenea amurensis* Selys. II. Reproductive period with special reference to territoriality. *J. Fac. Sci. Hokkaido Univ. Ser. VI Zool.* 19:812-833.
- Ueda, T. 1979. Plasticity of the reproductive behaviour in a dragonfly, *Sympetrum parrulum* Barteneff, with reference to the social relationship of males and the density of territories. *Res. Popul. Ecol.* 21:135-152.
- Waage, J.K. 1984. Sperm competition and the evolution of Odonate mating systems. In: Smith, R.L. (ed.) *Sperm competition and evolution of animal mating systems*. Academic Press, Orland pp. 251-290.
- Ward, J.V. & Stanford, J.A. 1982. Thermal responses in the evolutionary ecology of aquatic insects. *Ann. Rev. Entomol.* 27:97-117.

Table 1. The time investment of males in the swarming flight observed by focal animal sampling at the swarming site S on 15 and 16 April 1987.

succeeding behaviour	(15th) 10:35-12:10 (16th) 10:05-13:00		(15th) 14:10-17:55 (16th) 13:40-17:38		total duration
	n	duration mean (range)	n	duration mean (range)	
full observation*					
change site	2	15'51" (10'-21')	5	12'06" ( 7'-19')	7 92'32"
land (mate)	4(1)	11'20" ( 3'-24')	2	13'44" ( 8'-19')	6 72'51"
rest under leaf	1	9'51"	7	7'15" ( 3'-12')	8 60'44"
mean	7	12'25" ( 3'-24')	14	9'55" ( 3'-19')	21 10'45"
partial observation**	4	6'27" ( 2'-13')	6	5'23" ( 1 -15')	10 58'58"
total	11	112'43"	20	172'22"	31 285'05"

\* The male was observed fully from start to end of the swarming flight at the site S.

\*\* The time of start or end was uncertain, thus the duration was underestimation in this case.

Table 2. The daily mean mating success of swarming males (MSS) of Epeorus ikanonis.

date	total observed time [ $\Sigma td$ ] (min)	no. of ♂ observed [ $\Sigma NS$ ]	total male-minutes [ $\Sigma NS \times td$ ]	total no. of copulations	mean daily mating success [MSS] (no./male-minute) $\times 10^{-3}$
18 April 1986*	395	16***	3428	6	1.75
15 April 1987**	103	12	103	0	0.00
16 April 1987**	182	19	182	1	5.49
total	680	47	4713	7	2.41

\* Based on the counting of swarming males and matings at the site S at 33 intervals.

\*\* Based on the focal animal sampling of males at the site S. Observed time was shown in Table 2.

\*\*\* Daily maximum number of males observed at the site S, which dose not represent the daily real number of males attending the swarm.

Table 3. Estimate of the daily mean mating success for the assembly males (MSA)

date	total duration of observation units [ $\Sigma td$ ] (minutes)	no. of ♂ observed*	total male-minutes	total no. of copulations observed	total no. of copulations estimated [ $\Sigma CAT$ ] mean ( min.- max.)**	daily mean mating frequency [MSA] (no./male-minutes) $\times 10^{-3}$ mean ( min.- max.)**
9 April 1986	270	240	25081	12	57.2 ( 47.5- 72.0)	2.28 (1.89 - 2.87)
13 April 1986	387	943	178087	252	1322.8 (1098.4-1665.3)	7.43 (6.17 - 9.35)
14 April 1986	450	1019	236089	261	869.6 ( 722.1-1094.7)	3.68 (3.06 - 4.64)
17 April 1986	405	1185	269630	358	1946.8 (1616.6-2450.9)	7.22 (6.00 - 9.09)
total	1512	3387	708887	883	4196.4 (3484.6-5282.9)	5.15 (4.28 - 6.49)

\* Daily maximum number of males observed at the site C, which does not represent the daily real number of males attending the assembly. \*\* the minimum and the maximum estimates based on the -95% and +95% confidence limits of the copula duration (Takemon, part III) respectively.

Table 4. Percentage of virgin females (pv) captured at the assembly site C and the swarm site S on 15 April 1987 determined by the experiment of rearing eggs of each female. Females who had completed oviposition were not collected.

	females landed at the site C*	females flying at the site S*	total
	no. (%)	no. (%)	no. (%)
fertilized	14 (82.4)	6 (66.7)	20 (76.9)
unfertilized	3 (17.7)	3 (33.4)	6 (23.1)
total	17 (100.0)	9 (100.0)	26 (100.0)

\* The difference was not significant ( $P > 0.1$ , Fisher's exact probability test)

Table 5. Multiple copulations of female *Epeorus ikanonis* at the assembly site C observed by focal animal sampling in 1986 and 1987.

	1986 full focus* (%)	1986 partial** (%)	1987 full focus* (%)	total (%)	total copulations
once	19(90.5)	19(86.4)	48(87.3)	86(87.8)	86
twice	2( 9.5)	3(13.4)	6(10.9)	11(11.2)	22
three times	0( 0.0)	0( 0.0)	1( 1.8)	1( 1.0)	3
total	21	22	55	98	111

\* The females were observed fully from arrival to oviposition or to take-off

\*\* The females found on the ground were observed as focal individuals until oviposition or take off.

Table 6. Estimation of the probability of multiple copulation [Pn] and the mean number of copulations [M] for females from copulation with an assembly male to oviposition. C1-3: probability of multiple copulations from once to three times at the assembly site (shown in Table 5) Oa: probability of oviposition after copulation at the assembly site. F: probability of take off after copulation at the assembly site. Ps: probability of passing the swarming site without copulation. Cs: probability of copulation at the swarming site Ob: probability of direct oviposition by nonvirgin females after landing on the assembly site. Ca: probability of copulation by nonvirgin females after landing. (n): n times copulations occur only in the first landing and oviposit without take off. (1-3,0-1,n): 1-3 times copulations occur in the first landing and take-off 0-1 copulation with a swarming male after take off and n times copulations in the second landing.

	(n)	(1,0,n)	(1,1,n)	(2,0,n)	(2 1,n)	(3,0,n)	(3,1,n)	
P1 =	C1·Oa + C1·F·Ps·Ob							= 0.799520
P2 =	C2·Oa + C1·F·Ps·Ca·C1 + C1 F·Cs·Ob + C2·F·Ps·Ob							= 0.169931
P3 =	C3·Oa + C1·F·Ps·Ca·C2 + C1·F·Cs·Ca·C1 + C2·F·Ps·Ca·C1 + C2·F·Cs·Ob + C3·F·Ps·Ob							= 0.027405
P4 =	C1·F·Ps·Ca·C3 + C1 F·Cs·Ca·C2 + C2·F·Ps·Ca·C2 + C2·F·Cs·Ca·C1 + C3·F·Ps·Ca·C1 + C3·F·Cs·Ob							= 0.002894
P5 =	C1 F·Cs·Ca·C3 + C2·F·Ps·Ca·C3 + C2·F·Cs·Ca·C2 + C3·F·Ps·Ca·C2 + C3·F·Cs·Ca·C1							= 0.000237
P6 =	C2·F·Cs·Ca·C3 + C3·F·Ps·Ca·C3 + C3·F·Cs·Ca·C2							= 0.000012
P7 =	C3·F·Cs·Ca·C3							= 0.000000
M =	Σ n × Pn = 1.2344							

Values of each symbol: C1=0.8776; C2=0.1122; C3=0.0102; Oa=0.7674; F=0.2326; Ps=0.9841; Cs=0.0159; Ob=0.6276; Ca=0.3724.

Table 7 Estimation of the probability of multiple copulation [Pn'] and the mean number of copulations [M'] for females from copulation with a swarming male to oviposition. Symbols are the same as those in Table 6.

---

P1	=	Ob	=	0.627608
P2'	=	Ca·P1	=	0.297734
P3'	=	Ca·P2	=	0.063281
P4	=	Ca·P3	=	0.006481
P5'	=	Ca·P4	=	0.001078
P6'	=	Ca·P5	=	0.000088
P7'	=	Ca·P6	=	0.000004
P8'	=	Ca·P7	=	0.000000

$$M' = \sum n \times Pn' = 1.4448$$

---

Table 8. Expected reproductive success per copulation (ERC) for a swarming male when the mate has taken off from the assembly site after copulation with the assembly male. Pn type female copulates n times after landing on the assembly site until oviposition.

Pn: probability of n times copulation for a female, r: sperm precedence ratio, M: the mean number of copulations of a female.

female type	ERC
P2	$P2 \cdot r/M \times (1-r)^{2-2}$
P3	$P3 \cdot r/M \times [(1-r)^{3-2} + (1-r)^{3-3}]$
P4	$P4 \cdot r/M \times [(1-r)^{4-2} + (1-r)^{4-3} + (1-r)^{4-4}]$
P5	$P5 \cdot r/M \times [(1-r)^{5-2} + (1-r)^{5-3} + (1-r)^{5-4}]$
P6	$P6 \cdot r/M \times [(1-r)^{6-3} + (1-r)^{6-4}]$
P7	$P7 \cdot r/M \times [(1-r)^{7-4}]$

Appendix 1. List of Pn values used for the simulation of the expected mating success of assembly males. vra: an assumed virgin ratio of landed females at the assembly site. Po: probability for non-virgin females to oviposit without copulation after landing. Pc: probability for non-virgin females to copulate after landing. P1-7: probability for a mated female to copulate 1-7 times after her landing. N: mean number of copulations for a female after landing at the assembly site.

vra	Po	Pc	P1	P2	P3	P4	P5	P6	P7	N
0.00	.5169	.4831	.7773	.1862	.0324	.00374	.00031	.000016	0000002	1.2636
0.05	.5441	.4559	.7827	.1822	.0312	.00354	.00029	.000015	0000002	1.2564
0.10	.5743	.4257	.7888	.1778	.0298	.00330	.00027	.000014	0000002	1.2485
0.15	.6081	.3919	.7956	.1728	.0283	.00304	.00025	.000013	0000002	1.2396
0.20	.6461	.3539	.8032	.1672	.0266	.00275	.00023	.000011	0000001	1.2300
0.25	.6891	.3109	.8119	.1609	.0246	.00242	.00020	.000010	0000001	1.2182
0.30	.7384	.2616	.8218	.1536	.0224	.00204	.00017	.000008	0000001	1.2053
0.35	.7952	.2048	.8332	.1452	.0198	.00161	.00013	.000007	0000001	1.1903
0.40	.8614	.1386	.8465	.1355	.0168	.00110	.00009	.000004	0000001	1.1728
0.45	.9397	.0603	.8622	.1239	.0133	.00050	.00004	.000002	0000000	1.1522
0.48	1.000	.0000	.8743	.1151	.0106	.00004	.00000	.000000	0000000	1.1363

Appendix 2. List of Pn values used for a simulation of expected mating success of swarming males. vra: an assumed virgin ratio of landed females at the assembly site. vrs: possible range of virgin ratio at the swarming site. P1-8: probability for a mate of swarming males to copulate 1-8 times until oviposition. M: mean number of copulations by a mate of swarming males until oviposition.

vra	vrs	P1	P2	P3	P4	P5	P6	P7	P8	M
0.00	0.00-1.0	.5169	.3755	0900	.0157	.0018	.00015	.000008	.00000009	1.6105
0.05	0.05-1.0	.5441	.3569	0831	.0142	.0016	.00013	.000007	.00000008	1.5729
0.10	0.10-1.0	.5743	.3358	0757	.0127	.0014	.00012	.000006	.00000007	1.5315
0.15	0.15-1.0	.6081	.3118	0677	.0111	.0012	.00010	.000005	.00000006	1.4858
0.20	0.20-1.0	.6461	.2843	0592	.0094	.0010	.00008	.000004	.00000005	1.4352
0.25	0.25-1.0	.6891	.2524	0500	.0077	.0008	.00006	.000003	.00000004	1.3787
0.30	0.30-1.0	.7384	.2150	0402	.0059	.0005	.00004	.000002	.00000003	1.3153
0.35	0.35-1.0	.7952	.1707	0298	.0041	.0003	.00003	.000001	.00000002	1.2438
0.40	0.40-1.0	.8614	.1173	0188	.0023	.0002	.00001	.000001	.00000001	1.1625
0.45	0.45-1.0	.9397	.0520	0075	.0008	.0000	.00000	.000000	.00000000	1.0694
0.48	0.48-1.0	.0000	.0000	0000	.0000	.0000	.00000	.000000	.00000000	1.0000

## LEGENDS

Fig.1. Seasonal change of the emergence of subimagines (a) and (b), adult activities (b) of *Epeorus ikanonis*, and weather and temperature conditions (c) at the study site. (b) Black and white circles represent the daily maximum number of males and females found in the assembly site C, respectively. Black squares represent the daily maximum number of flying males at the swarm site S. (c) Upper symbols show the weather conditions in the day time: black circle rain, white very fine, with bar fine and double circles cloudy. Upper and lower solid line is the daily maximum and minimum air temperature, respectively. Dotted lines express the water temperature in the same way.

Fig.2. Diel change of the reproductive behaviour of *Epeorus ikanonis*. (a) Diel change of the number of sitting males, copulation pairs and ovipositing females in the assembly site C. (b) Diel change of the number of flying males, and the time copulations were found at the swarm site S. The swarm was observed continuously only on 18 April. (c) Diel change of the number of flying females across the swarming site S. The shaded period represents no data.

Fig.3. Relations of the number of sitting males (a), copulating pairs (b) and ovipositing females (c) in the assembly to the atmospheric temperatures observed with *Epeorus ikanonis*. Arrows show the pattern of diurnal sequence. Symbols in (b) and (c) are the same as in (a).

Fig.4. Seasonal change of the relative abundance of swarming males to assembly males in *Epeorus ikanonis*. Each value was obtained by the daily total number of swarming males divided by the daily maximum number of assembly males. See text for the estimation method of the daily total number of swarming males.

Fig.5. Diel change of the mean mating success (no./male-minute) of assembly males (CAT) at the site C. The ends of a vertical bar at each plot represent the maximum and the minimum estimate derived from the 95% confidence limits of the mean copula duration used for estimating the number of copulations in an observation unit.

Fig.6. (a) Relation of the expected male reproductive success for a copulation (ERC) to the sperm precedence value ( $r$ ) in *Epeorus ikanonis*. (b) Relation of the expected mean reproductive success per male-minute (ERM) to  $r$ . The upper and the lower solid curves represent the maximum and the minimum estimates, based on the -95% and the +95% confidence limit of the duration required for a copulation at the assembly site, respectively.

Fig.7. (a) Relation of ERM to  $r$  using various virgin ratios of females ( $pv$ ) for assembly males. The highest line, the lowest line, and the other lines correspond to the case of  $pv=0.48$ ,  $pv=0.00$ , and the intermediate values of  $pv$  set at 0.05, respectively. The maximum and the minimum estimations are derived from the -95% and the +95% confidence limits of copula duration at the assembly site, respectively. (b) Relation of ERM to  $r$  by the possible ranges of virgin ratio ( $pv$ ) for swarming males. The shaded triangle was obtained by the range of  $pv$  from 0.48 (the base line) to 1.00 (the upper line). The other triangles correspond to each minimum  $pv$  assumed, which was set at 0.05 intervals between 0.00 to 0.48. The  $pv$  at the assembly site was assumed to be the minimum  $pv$  at the swarming site.

Fig.8. (a) An example for the process of determination of the value  $r$  balancing the ERM of each mate-locating behaviour. The deeply shaded area represents the equilibrium area when  $p_v=0.2$  at the assembly site. (b) The range of  $r$  balancing the ERM of each mate locating behaviour for each possible value of  $p_v$  and mating success at the assembly. The maximum estimates of the value  $r$  shown as the vertical dotted lines are 0.32, 0.40 and 0.46 according to the range of copulation frequency estimated for the assembly males.

Fig.9. Seasonal reduction of the sperm amount reserved in the adults collected by the emergence traps. The sperm amount was measured as projection area of the sperm reservoir.

Fig.10. (a) Relation of the relative amount of sperm to the fore wing length in sitting males at the assembly site C (open circles). Closed circles and a regression curve represent the case of virgin males obtained by emergence traps. (b) That in flying males at the swarm site S (open circles). Closed circles and a regression curve are the same as (a). (c) and (d) Relation of the sperm remainder to the fore wing length in sitting males and in flying males, respectively. The sperm remainder is shown as the percentage when the sperm amount of the virgin male is regarded as 100%. The horizontal dotted line shows the 95% confidence limit of the sperm amount of virgin males. The cross in the figure shows the mean value and the range of standard deviation of fore wing length and sperm remainder.

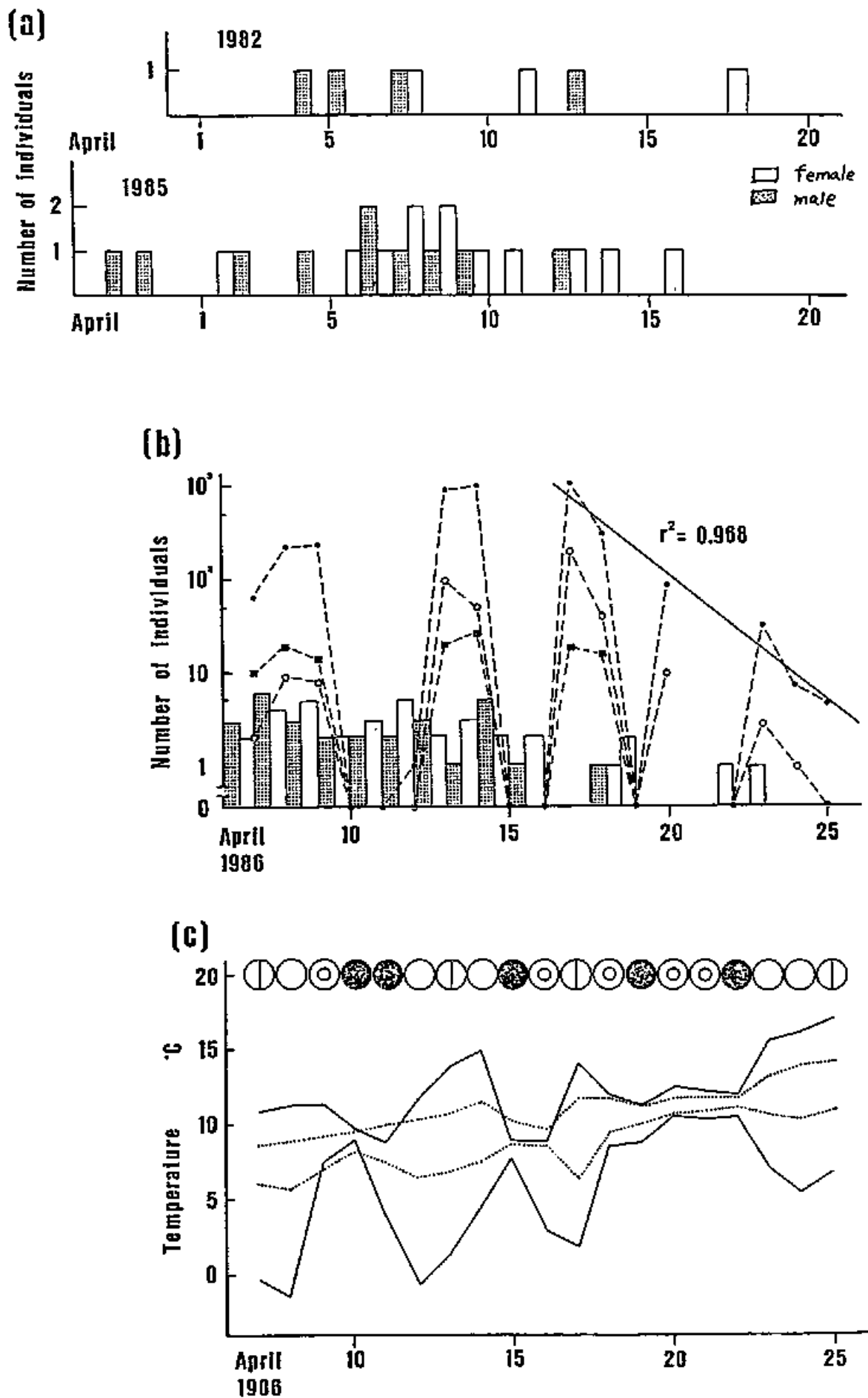

Fig. 1.

Takeemon, Y.

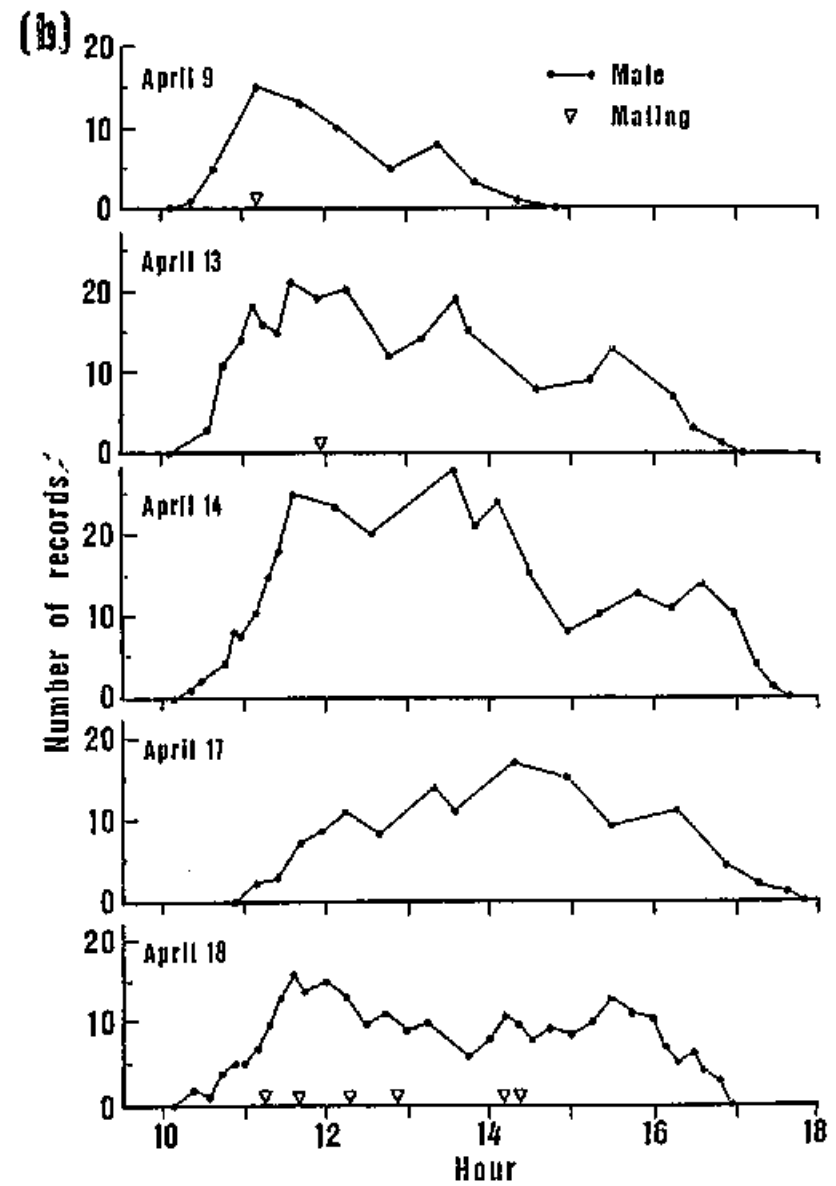
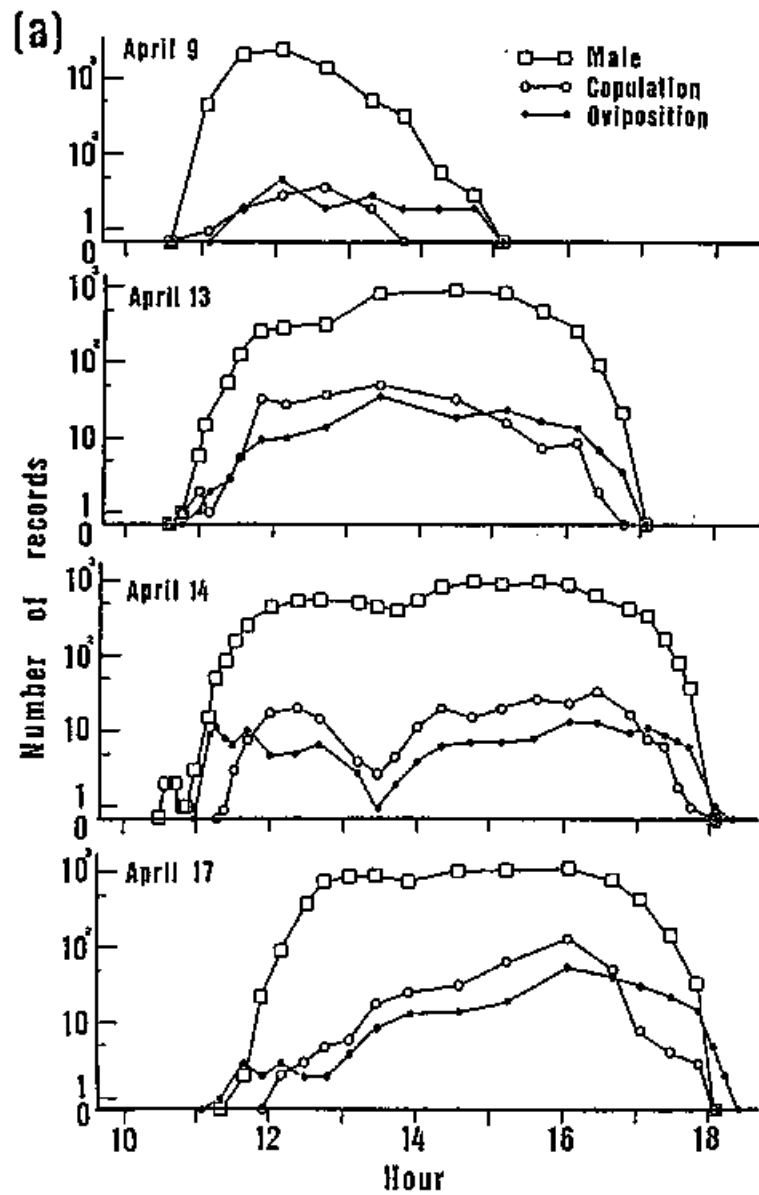

Fig. 2.

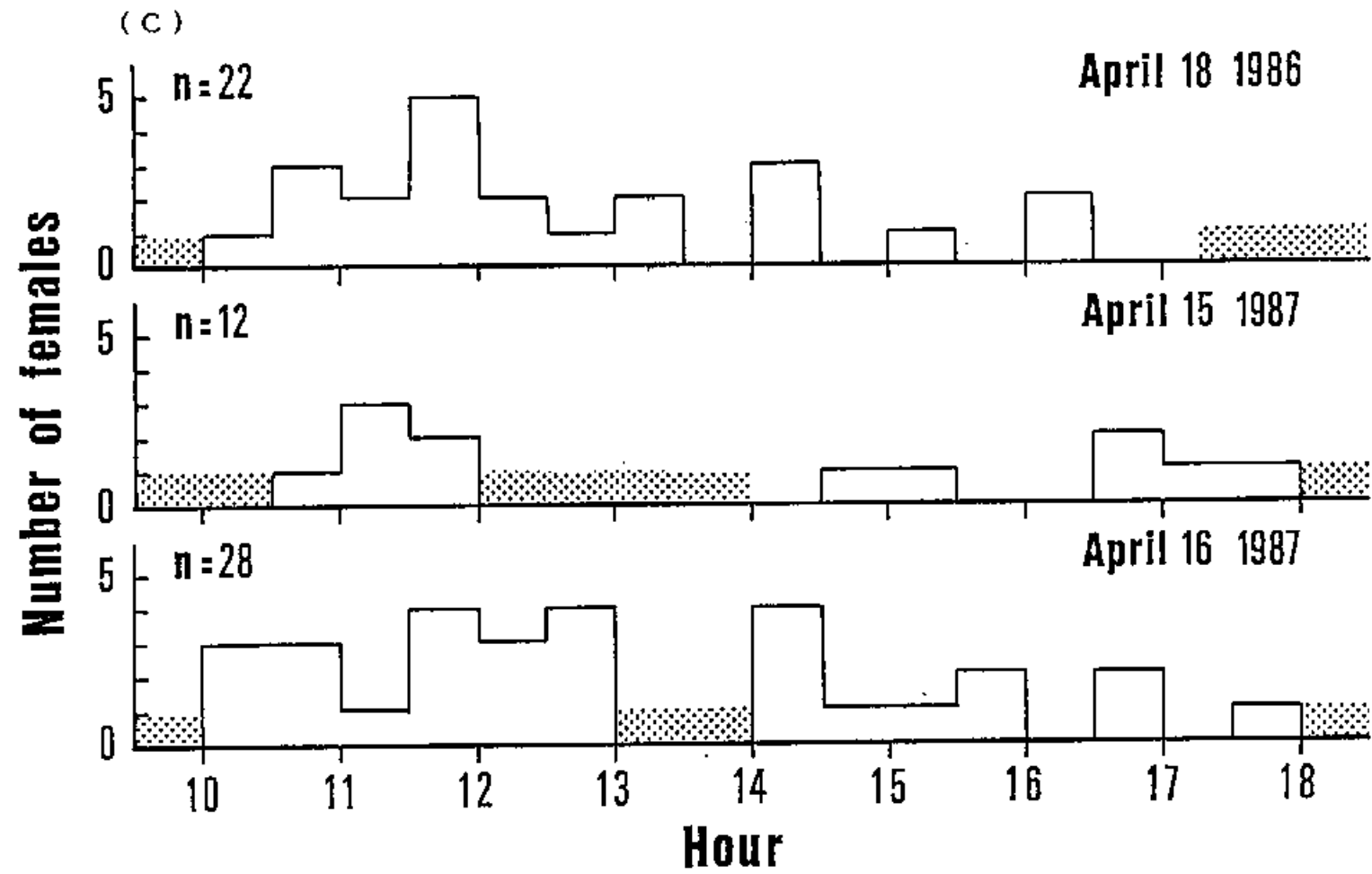

Fig. 2.

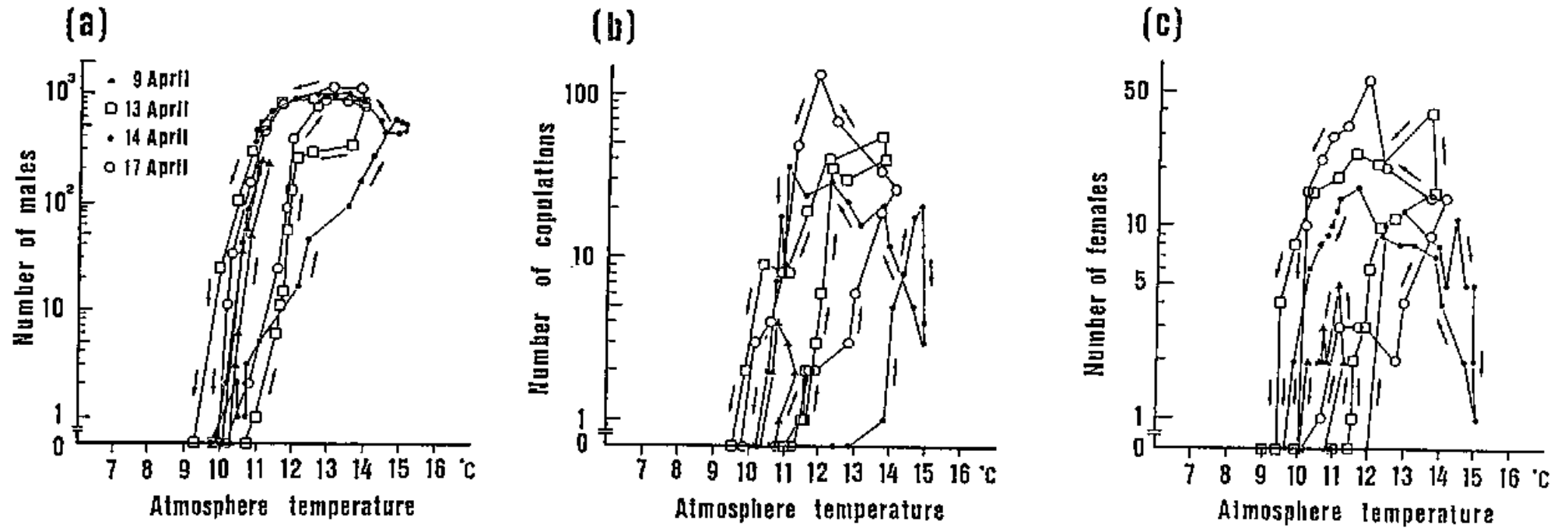

Fig. 3.

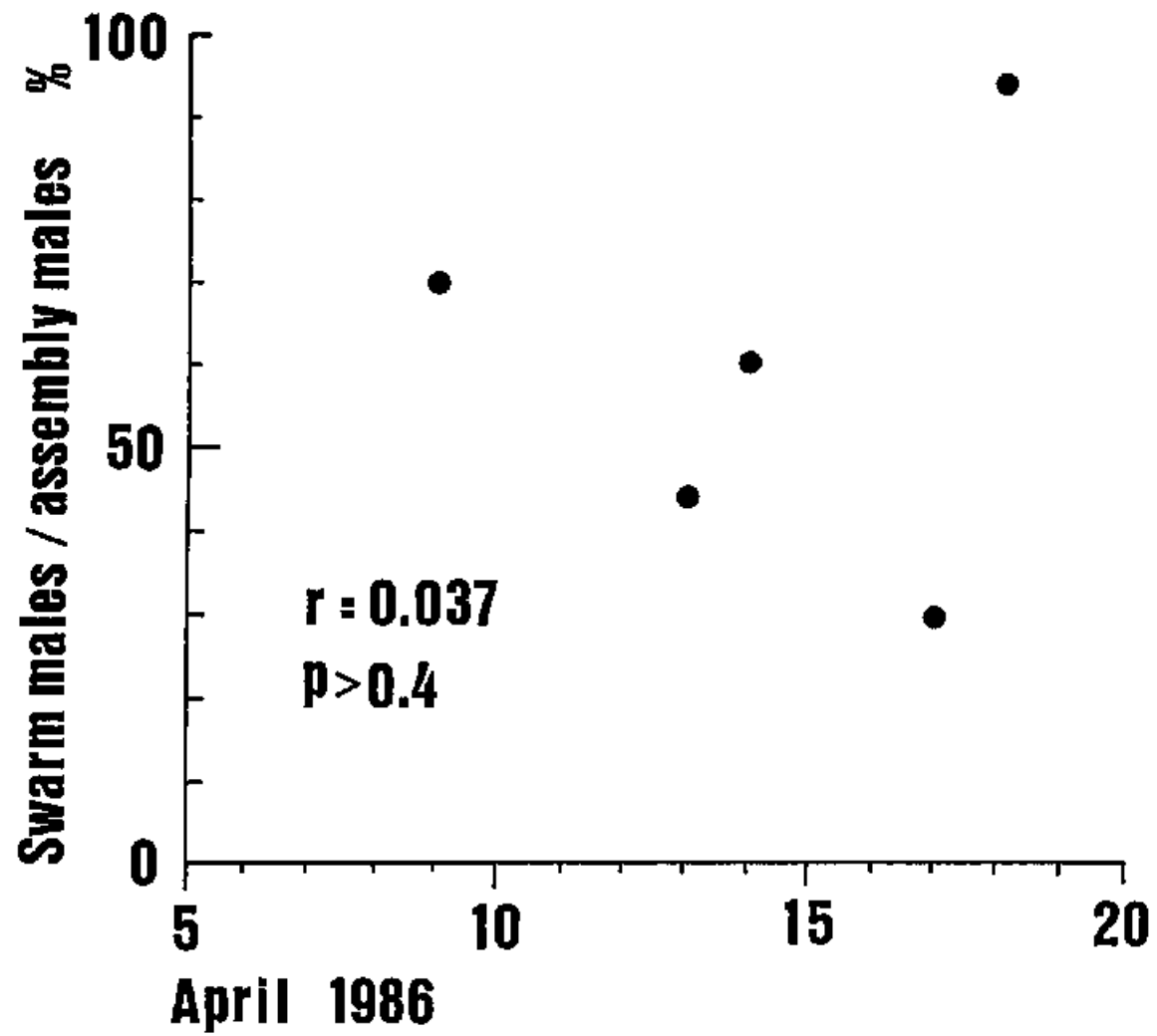

Fig. 4.

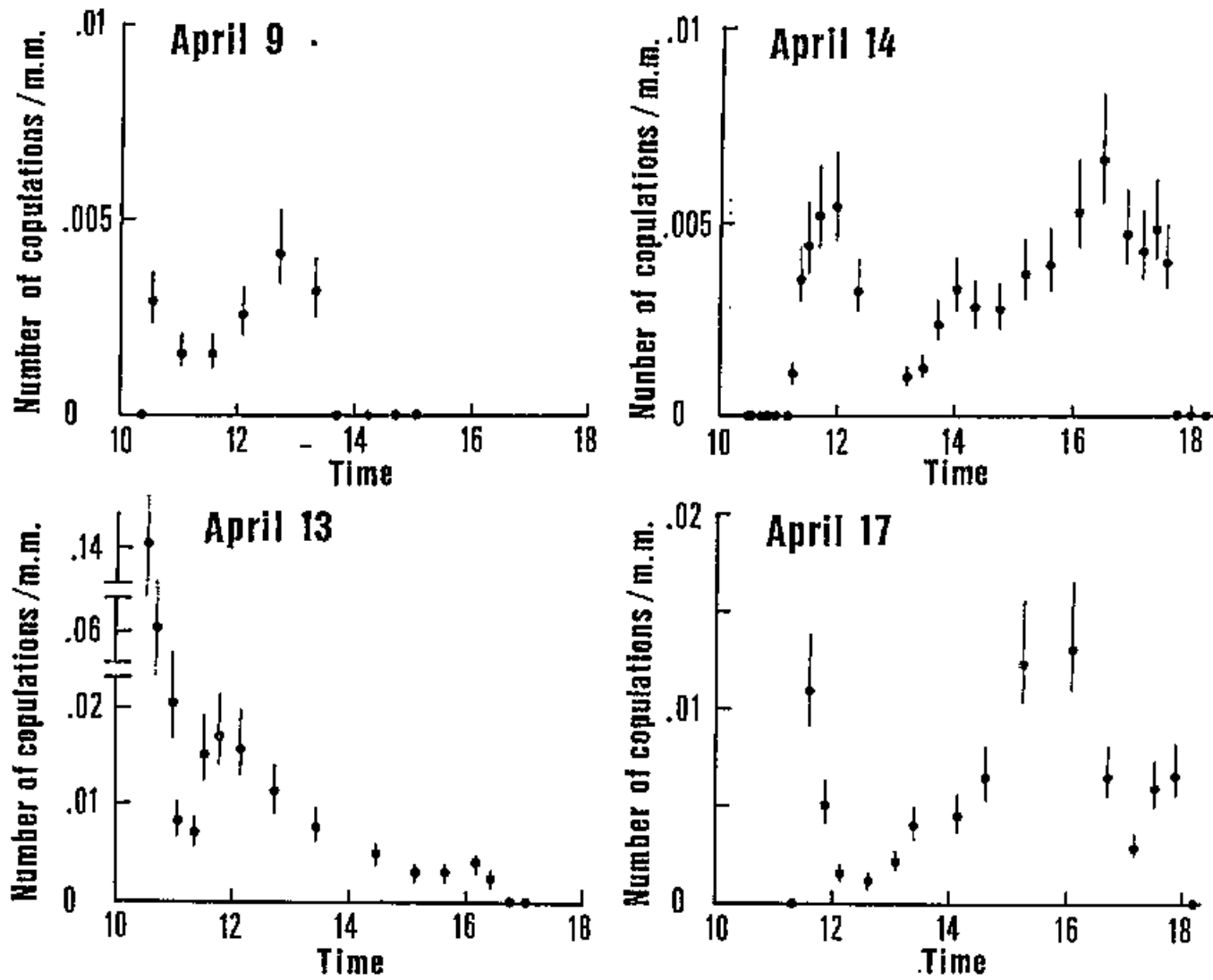

Fig. 5.

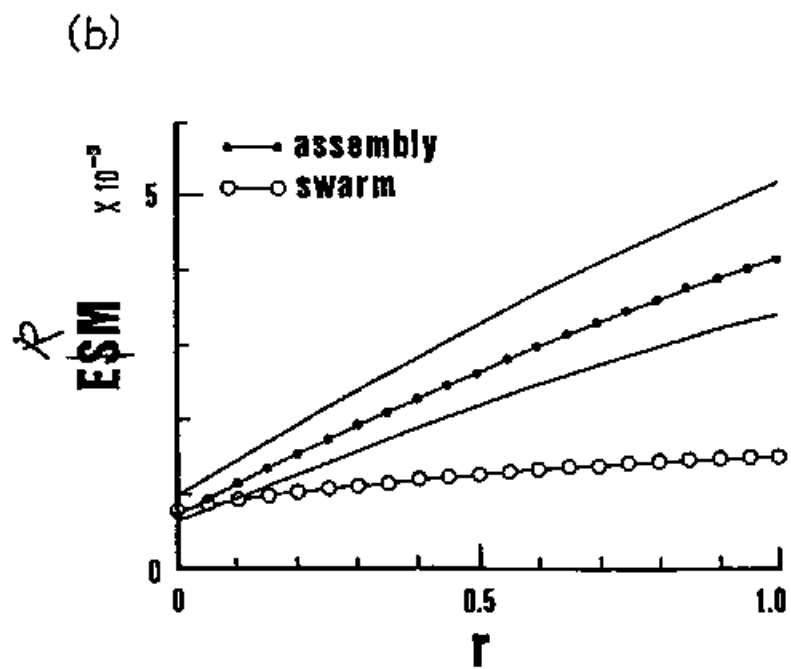
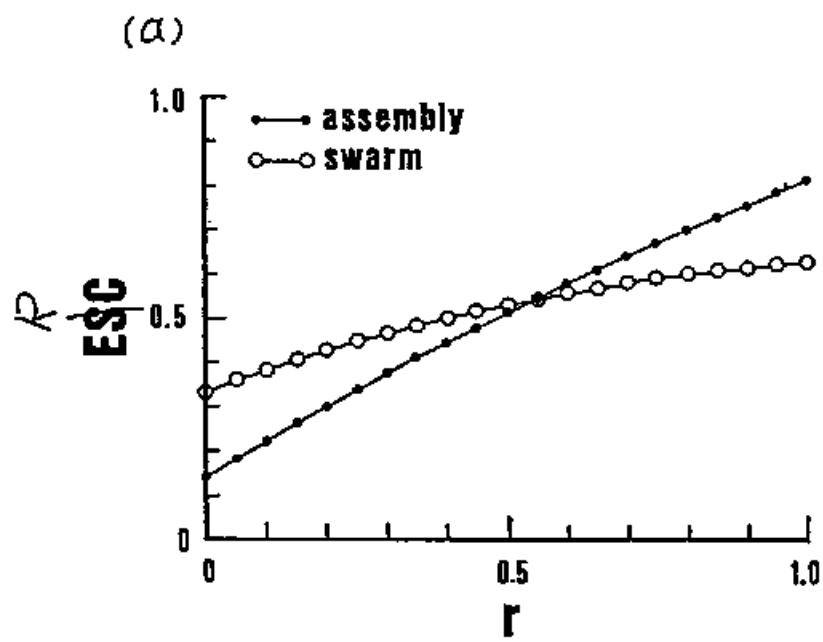

Fig. 6.

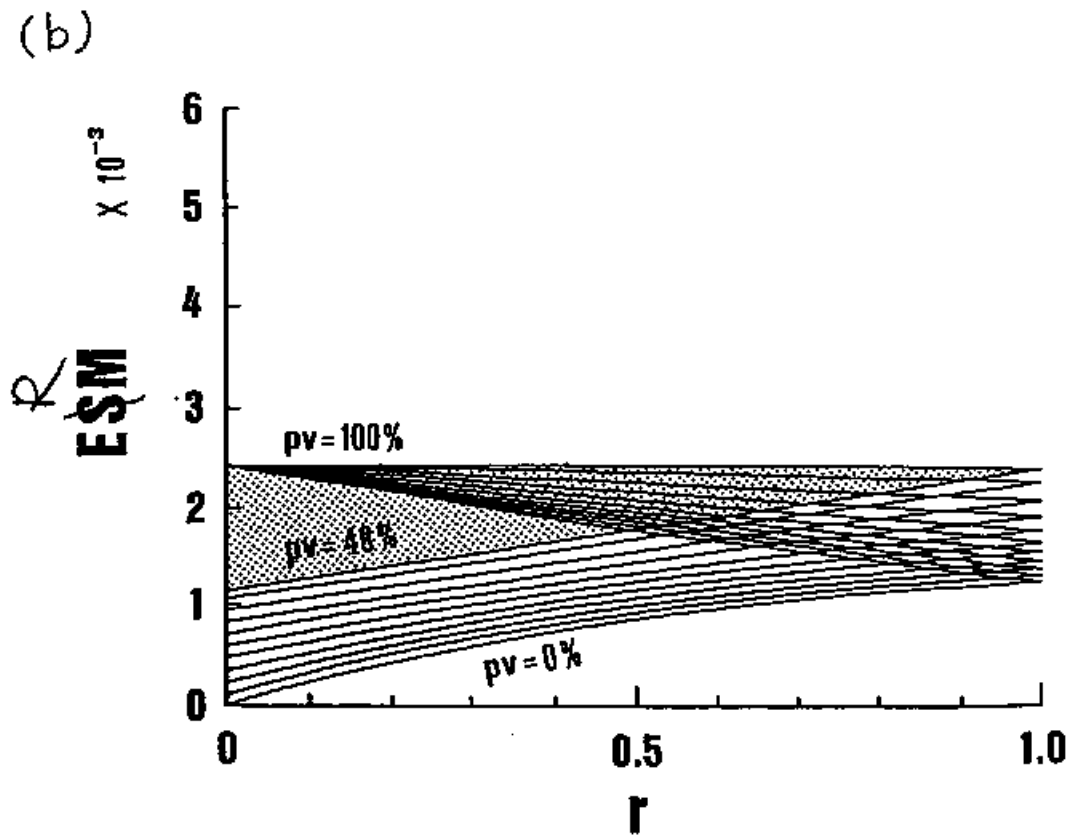
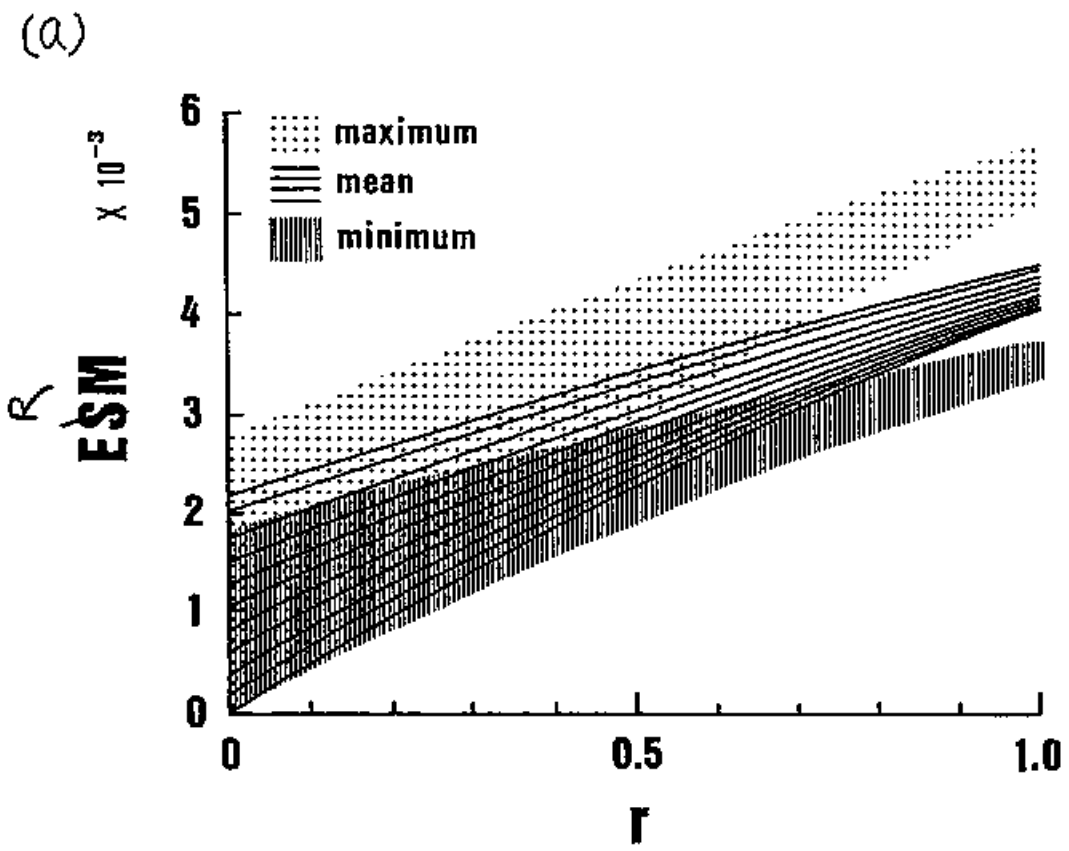
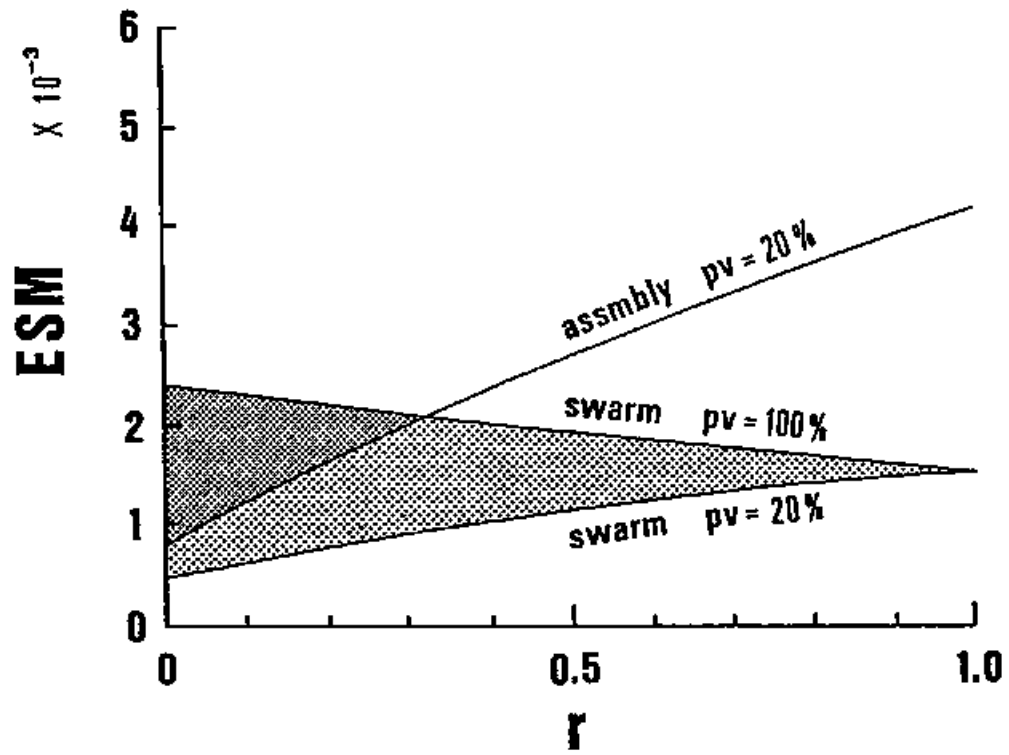

Fig. 7.

(a)



(b)

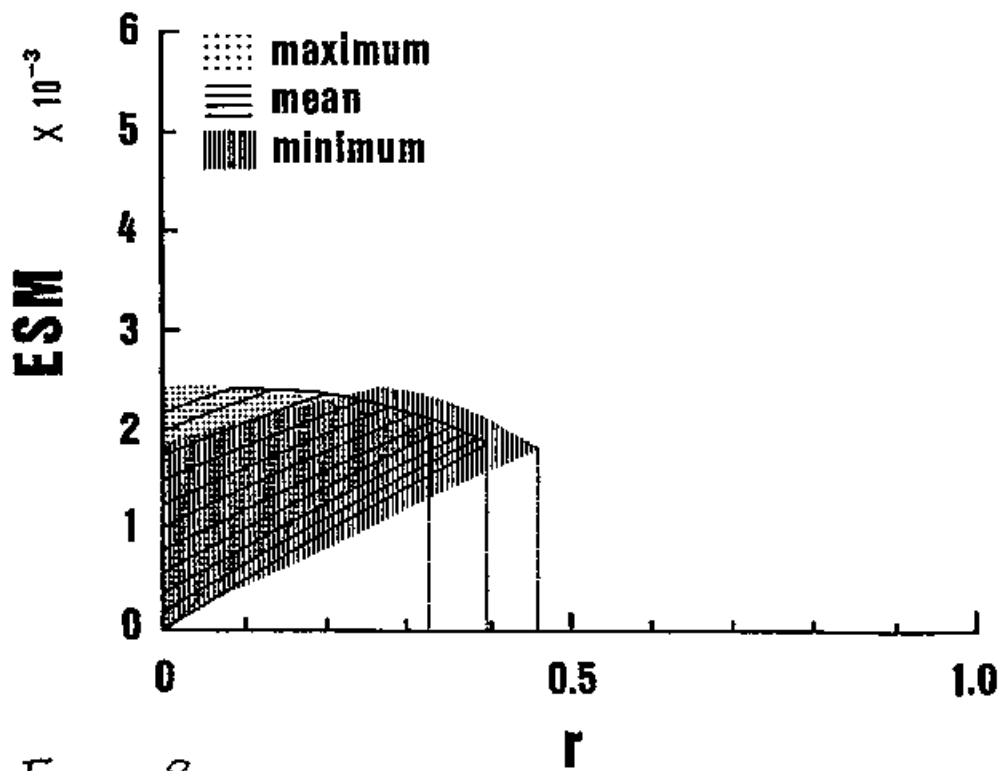

Fig. 8.

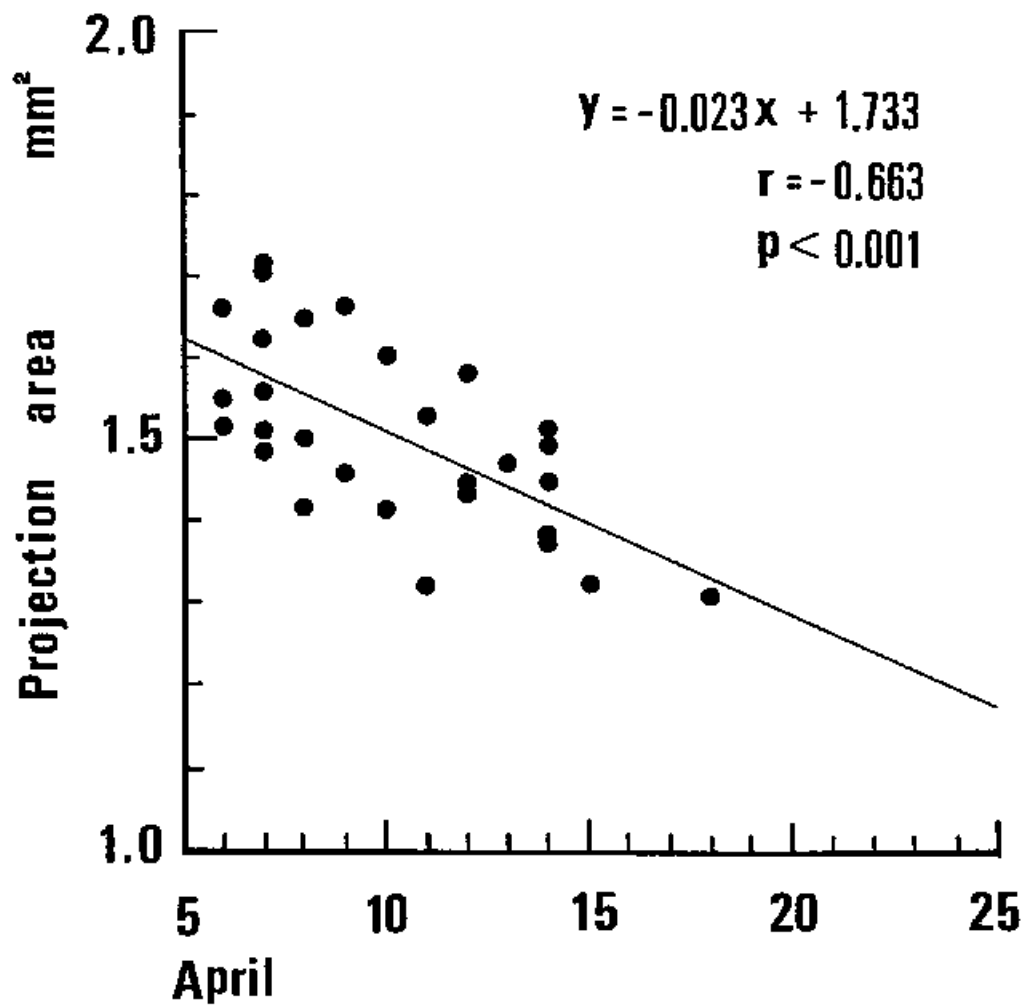

Fig. 9.

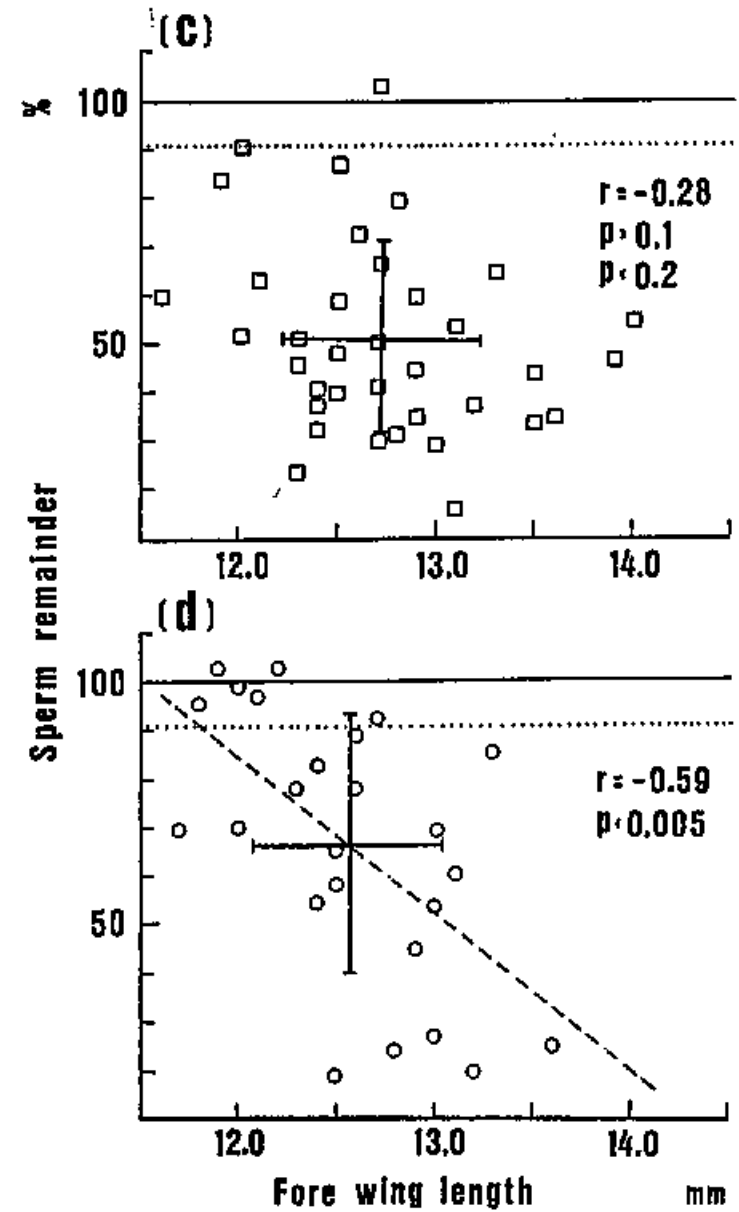
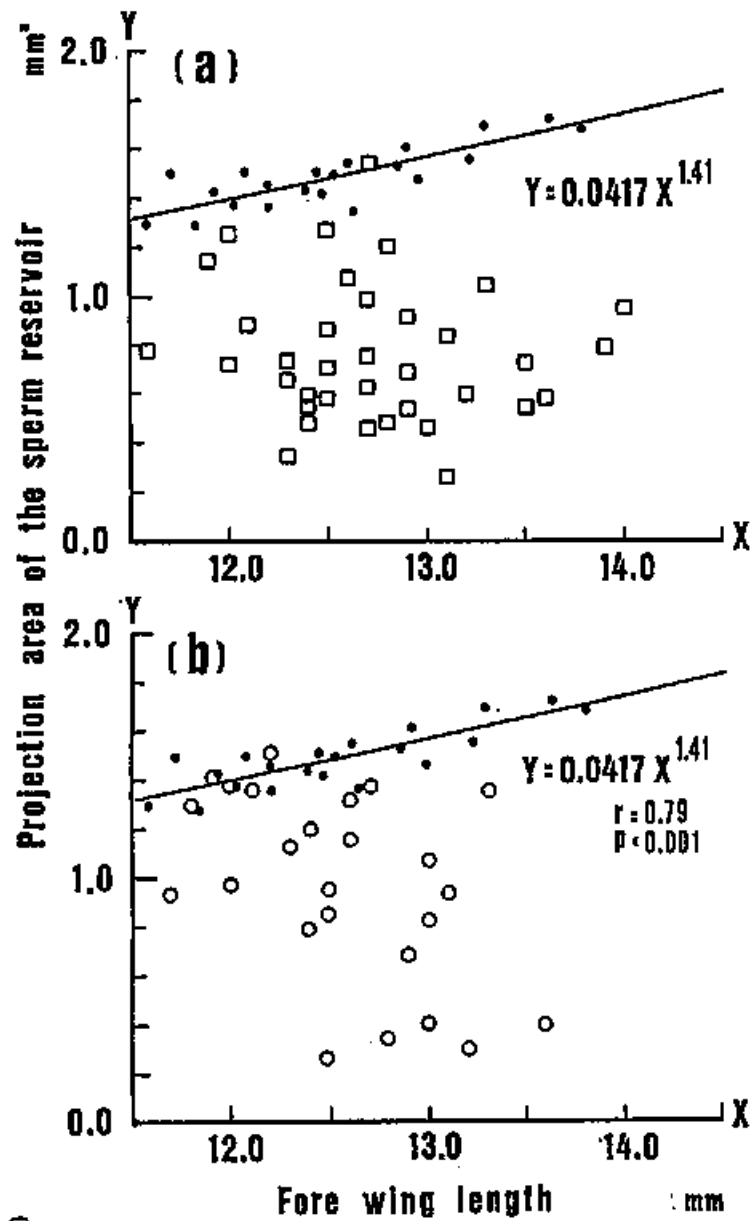

Fig. 10.